

WARP: Hardware

Siddharth Gupta & Patrick Murphy

WARP Workshop
Rice University
November 14, 2008



warp.rice.edu



Questions From Lab I?

WARP Hardware

- WARP Hardware Components
 - FPGA Board
 - Radio Board
 - Clock Board
- FPGA Architecture
- WARP Design Flows

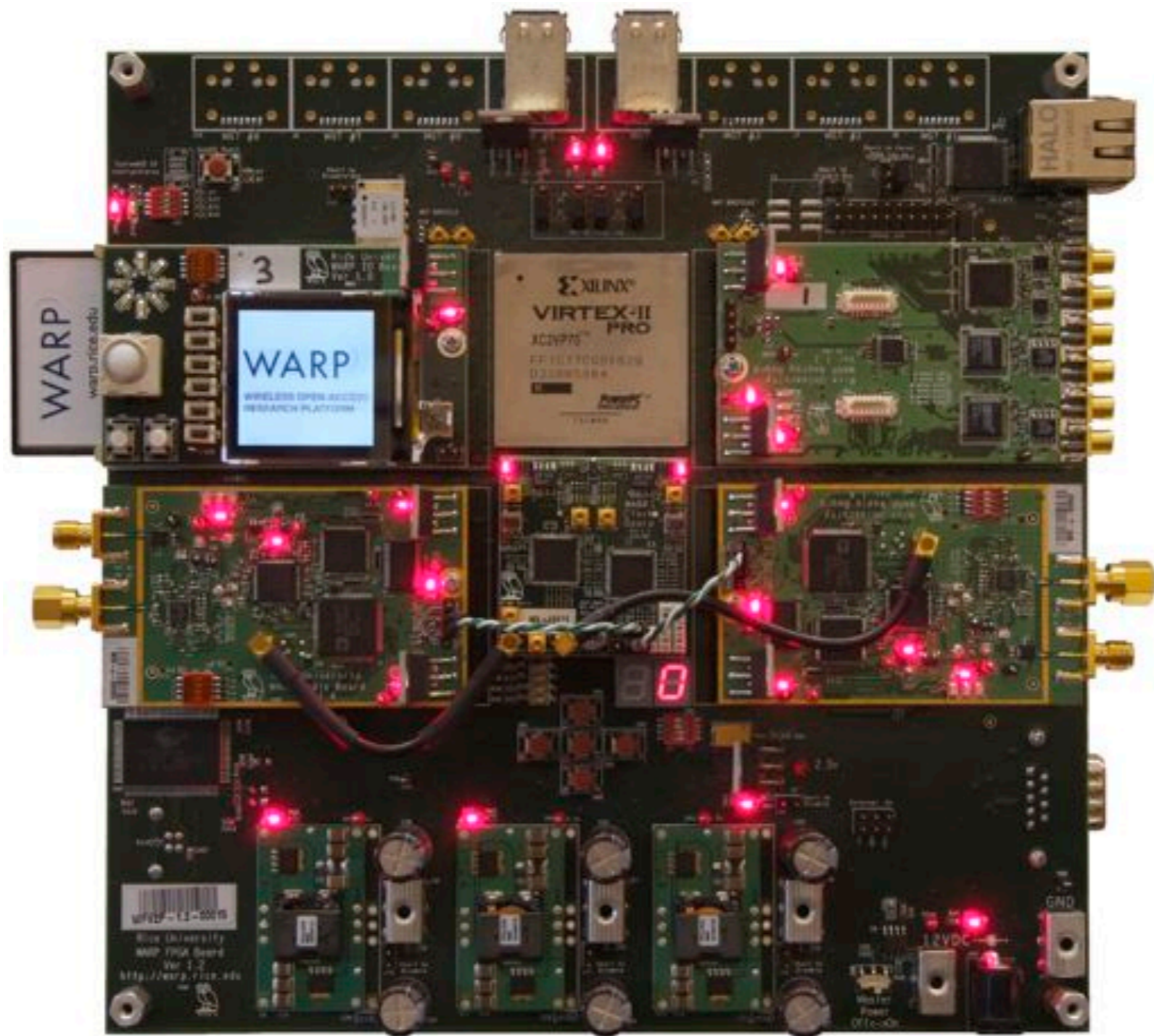

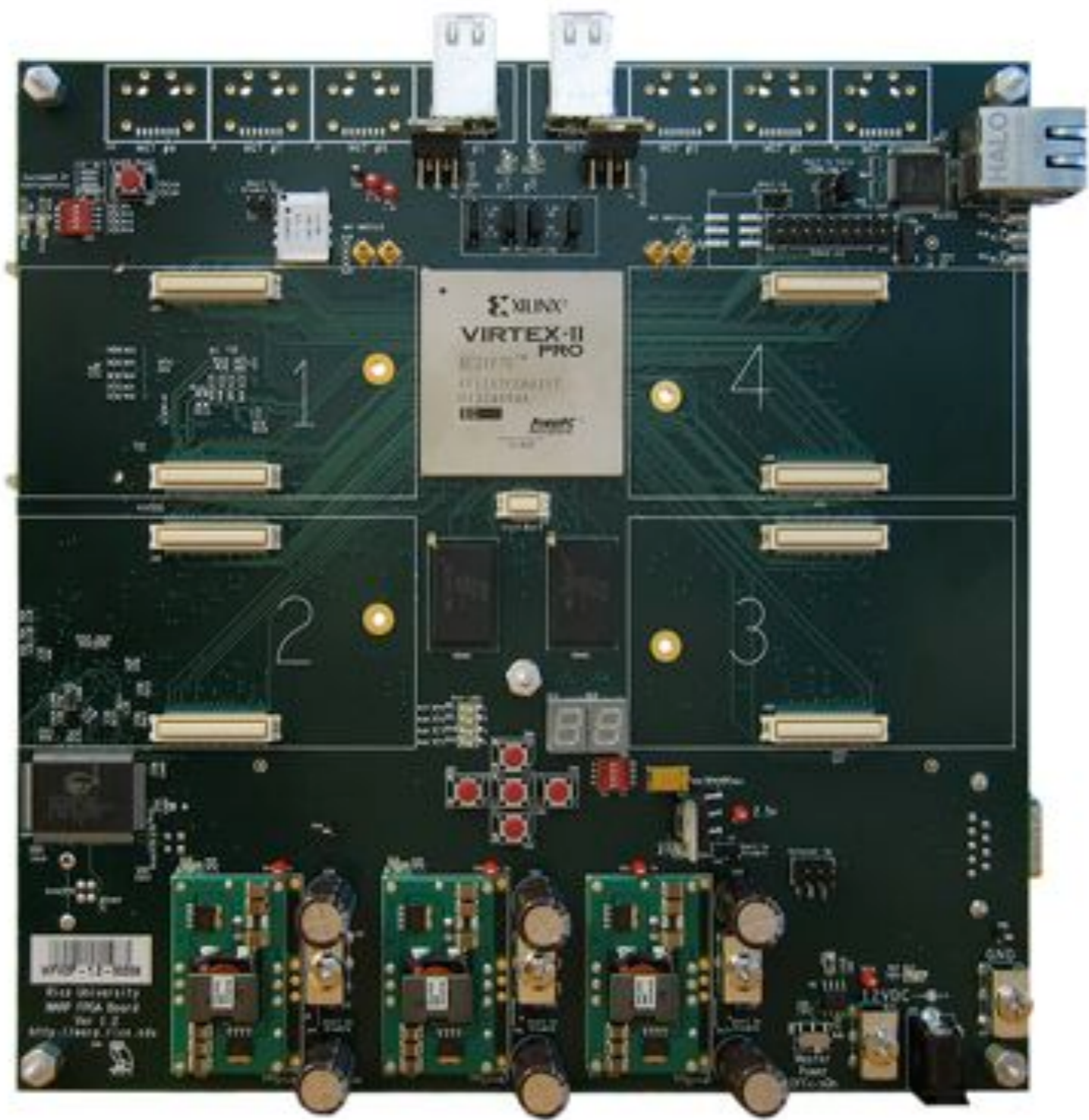

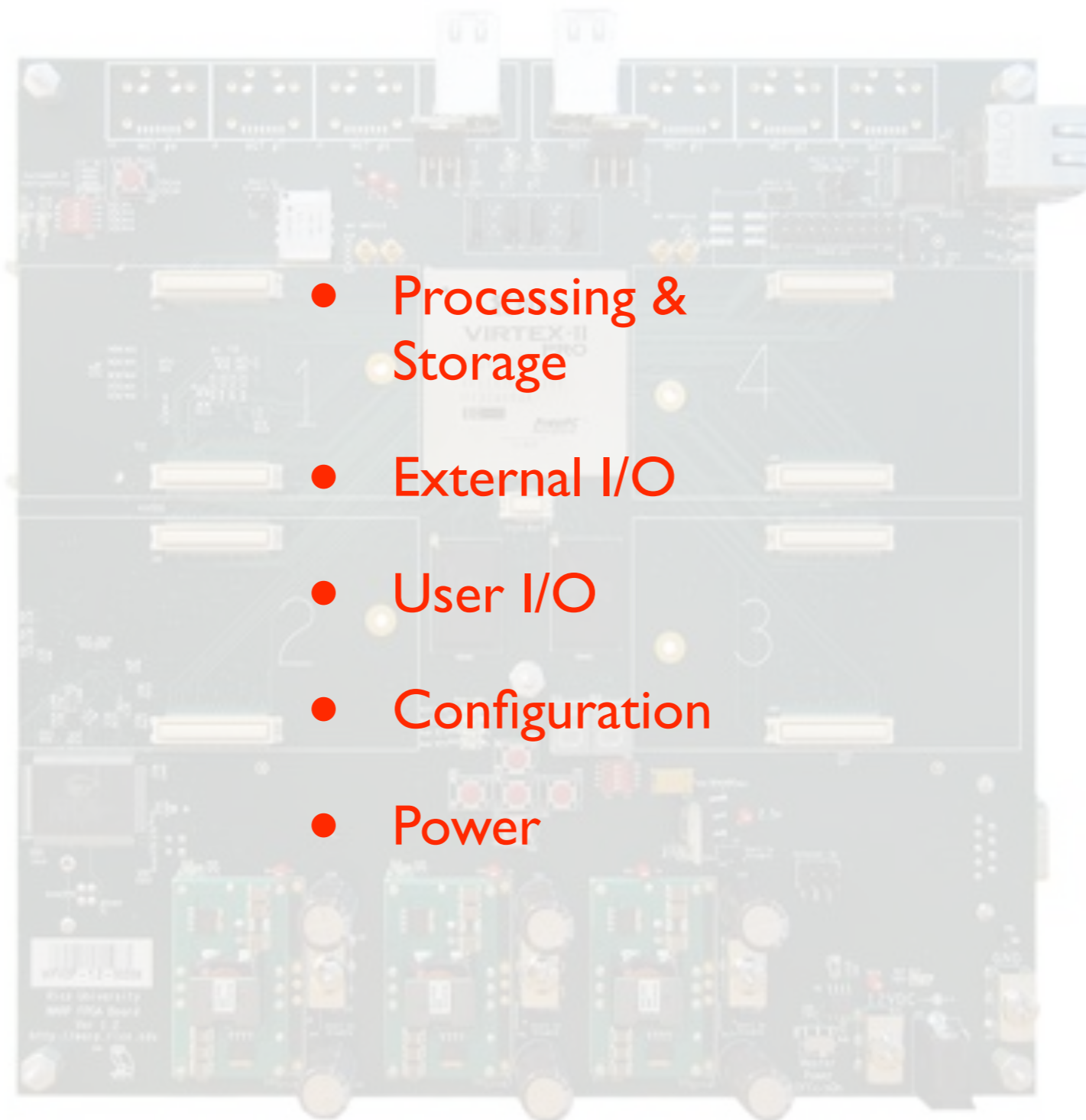

- Processing & Storage

- External I/O

- User I/O

- Configuration

- Power

Processing & Storage : XC2VP70 FPGA

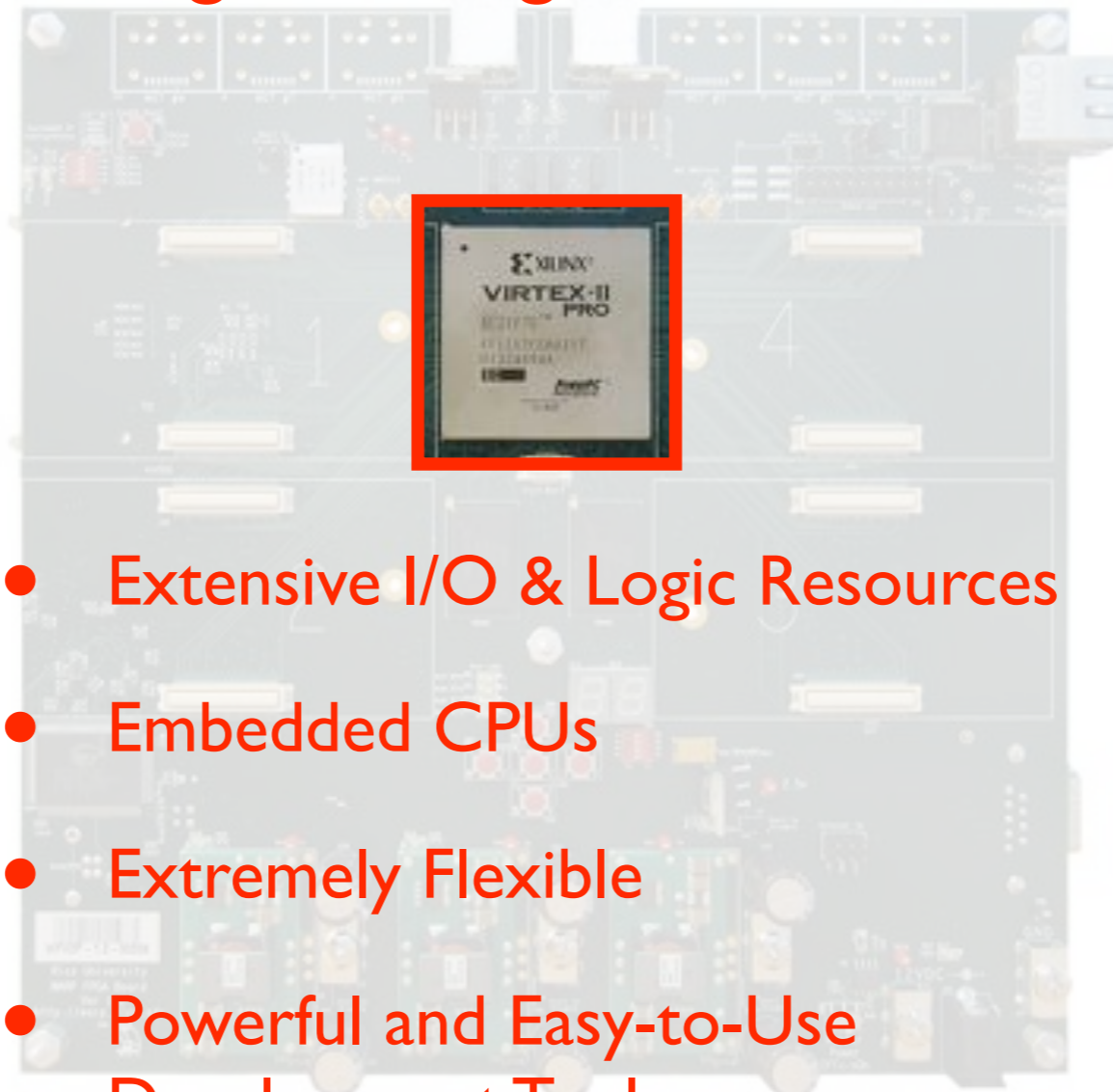

- Extensive I/O & Logic Resources
- Embedded CPUs
- Extremely Flexible
- Powerful and Easy-to-Use Development Tools

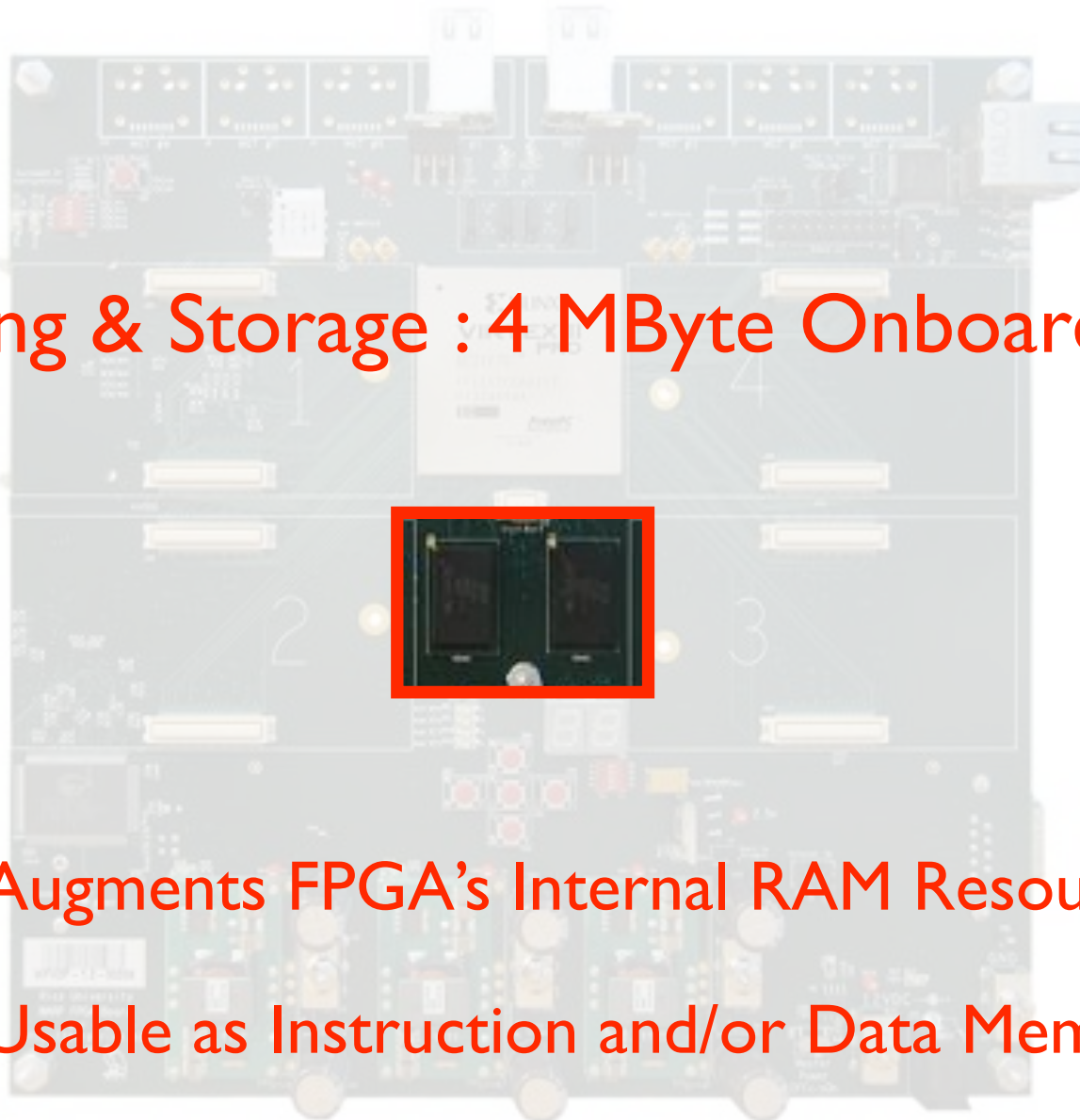

Processing & Storage : 4 MByte Onboard SRAM

- Augments FPGA's Internal RAM Resources
- Usable as Instruction and/or Data Memory
- Two ICs, Each 512K x 32

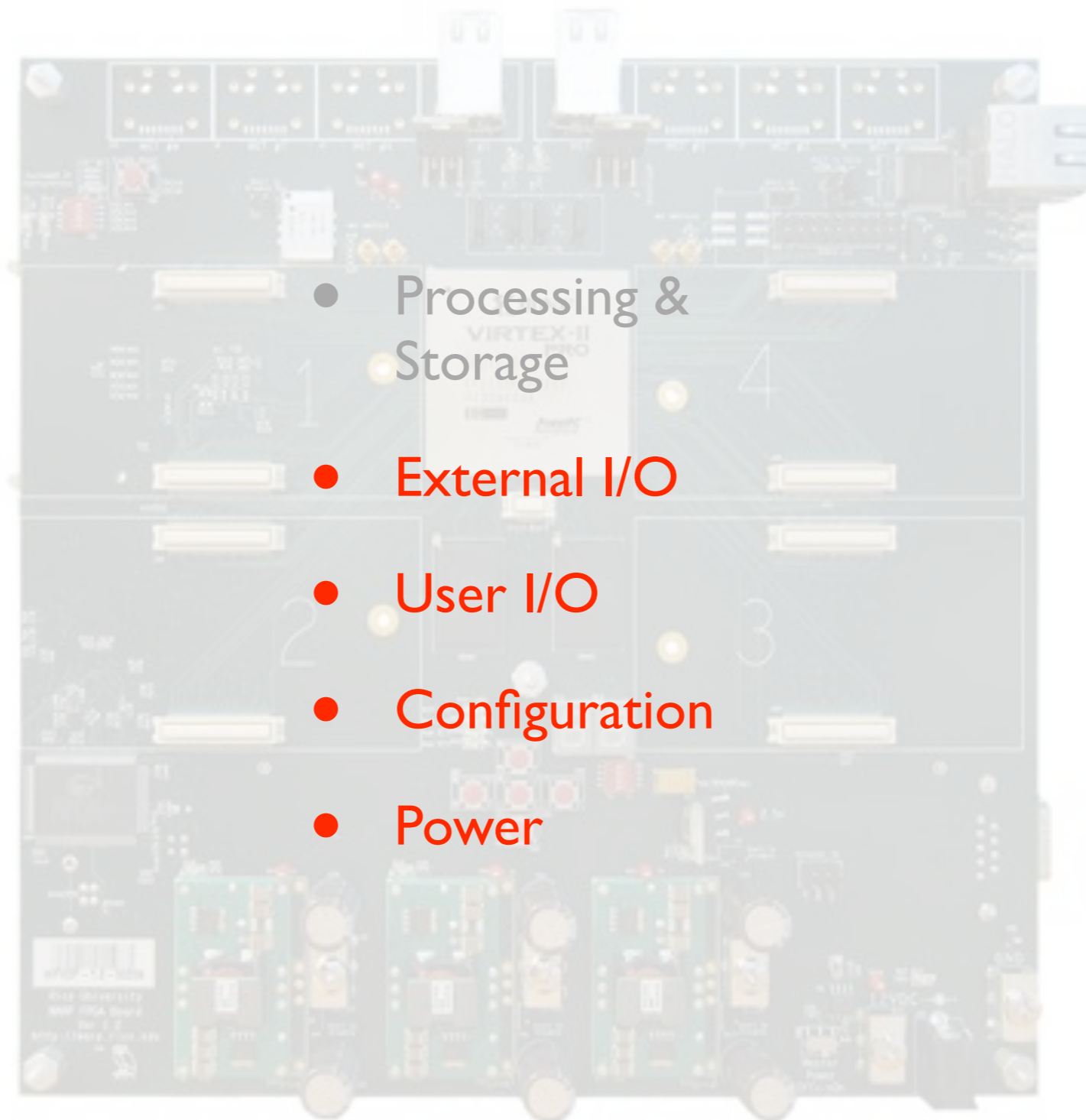

- Processing & Storage

- External I/O

- User I/O

- Configuration

- Power

External I/O : Serial Port

- Basic Input/Output To/From FPGA's Embedded Processors
- Very Useful in Debugging User Applications
- Data Rates Up To 1 Mbps

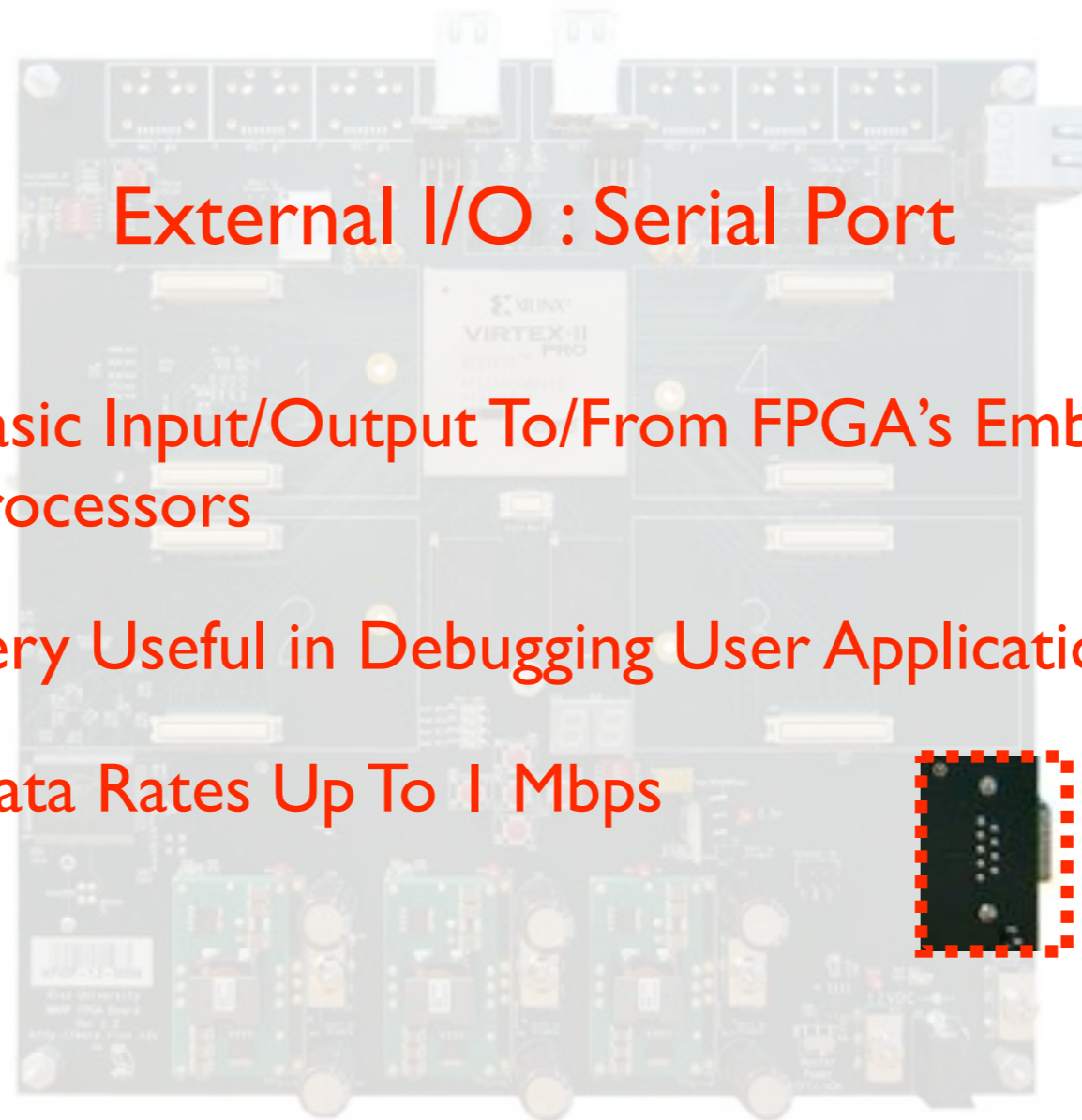

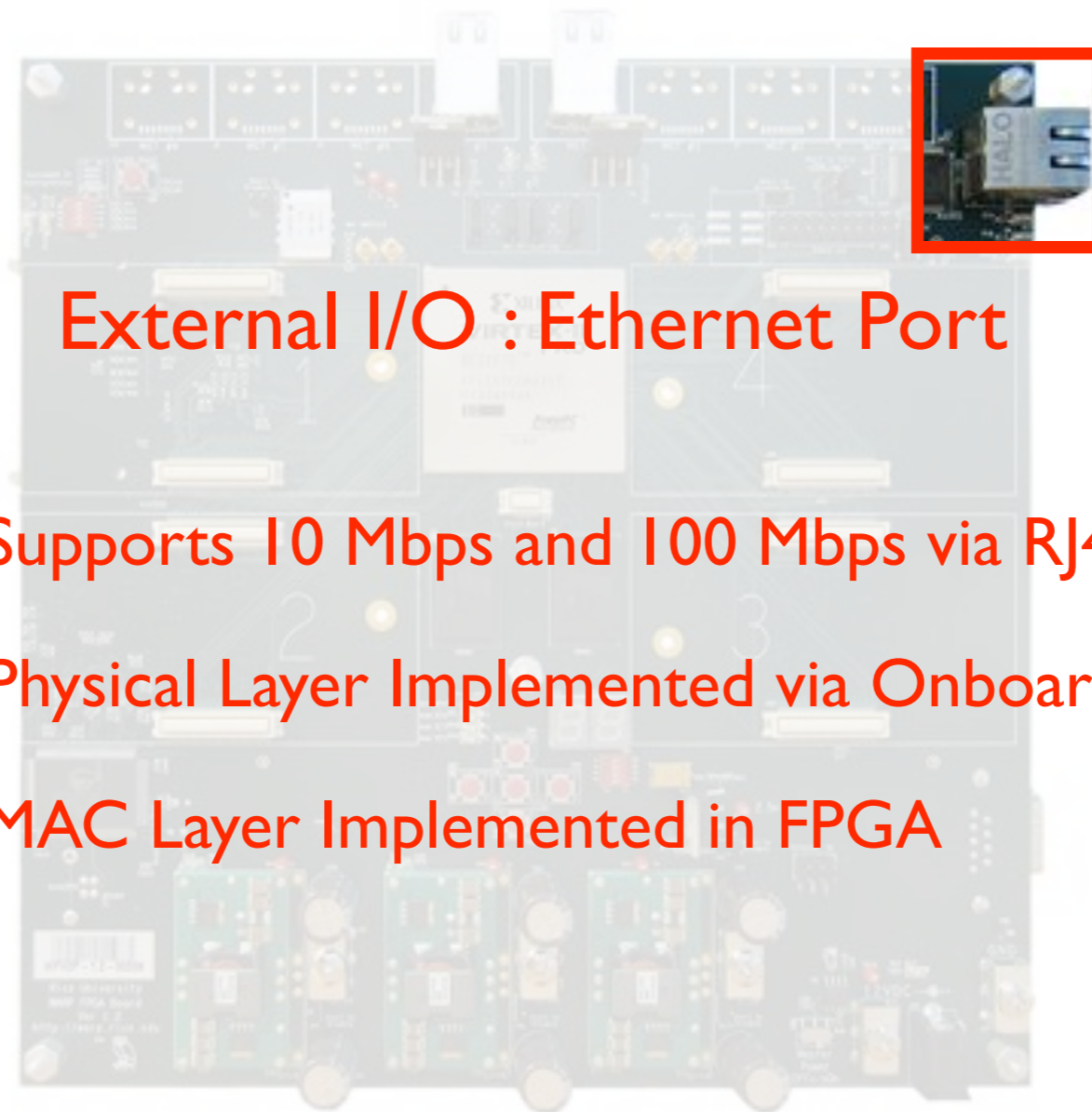

External I/O : Ethernet Port

- Supports 10 Mbps and 100 Mbps via RJ45
- Physical Layer Implemented via Onboard IC
- MAC Layer Implemented in FPGA



External I/O : Multi-Gigabit Transceivers

- High Performance Serial Links (3.125 Gbps Full Duplex)
- Inter-Board Communication for Multi-FPGA Processing

External I/O : Daughtercard Connectors



- Provide Expanded Functionality via Custom Daughtercards
- Connect to FPGA Through General Purpose Digital I/Os
- Protocol Defined By Logic and Software Residing in FPGA
- Supports Radios, Video Cards, A/D & D/A Cards, Others

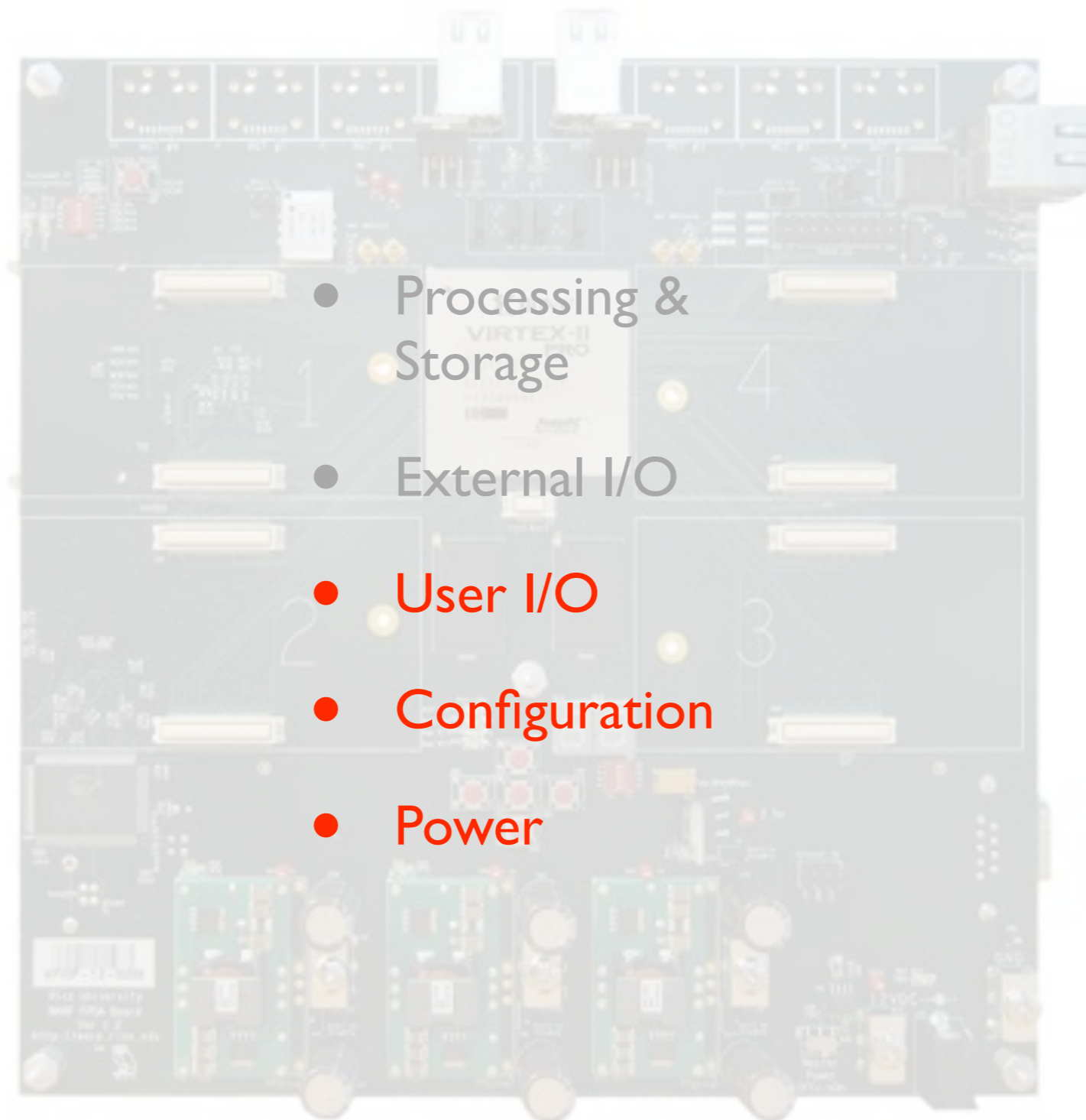

- Processing & Storage

- External I/O

- User I/O

- Configuration

- Power

User I/O : Switches, Buttons, LEDs

- Discrete and 7-Segment LEDs Provide Visible Status
- Buttons and Switches Provide Mechanism for User Input

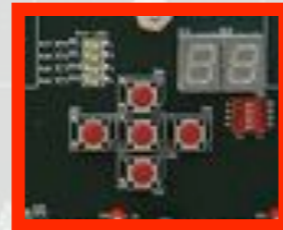



User I/O : Generic 20-Pin Header

- Direct Connection to 16 FPGA Pins and 4 Ground Signals
- Allows FPGA Signals to be Driven Off-Board
- Enables Viewing of Critical Signals During Low-Level Debugging

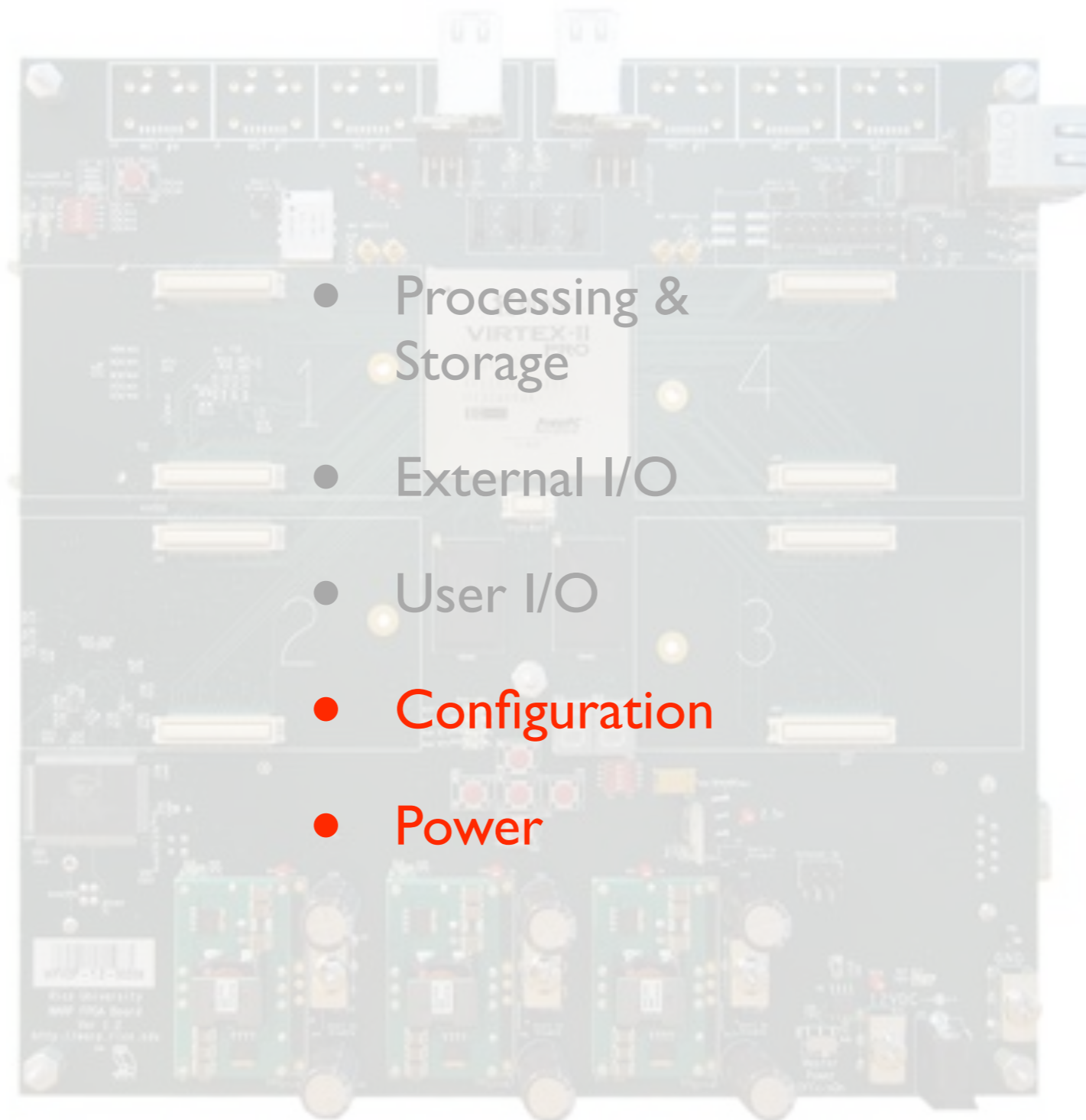

- Processing & Storage

- External I/O

- User I/O

- Configuration

- Power

Configuration : Compact Flash Slot

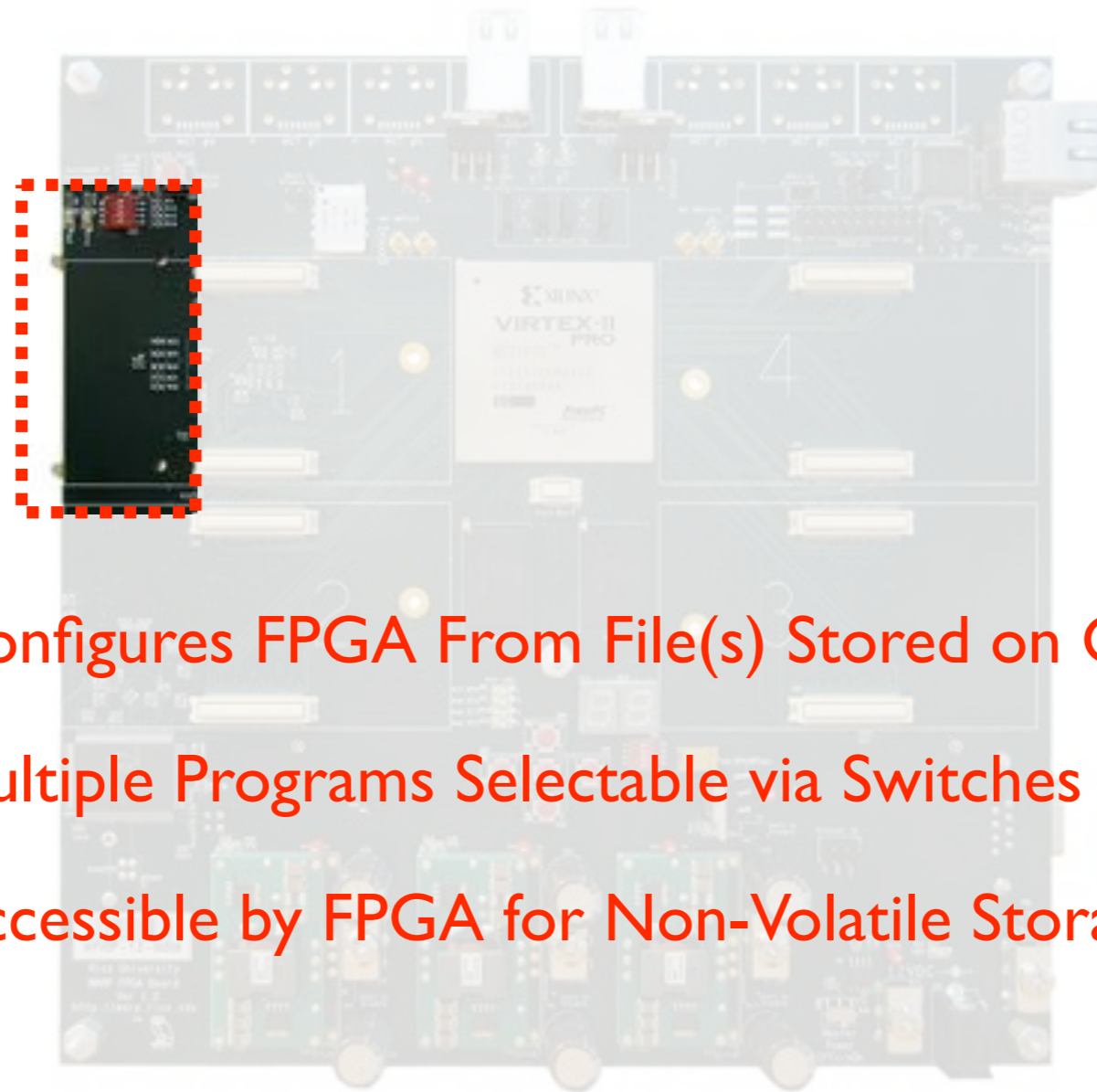

- Configures FPGA From File(s) Stored on CF Card
- Multiple Programs Selectable via Switches on PCB
- Accessible by FPGA for Non-Volatile Storage

Configuration : JTAG Header

- Connects to Xilinx Parallel IV or Platform USB Configuration Cables
- Used to Configure FPGA From PC During Development



- Provides Interface for Debugging Tools (e.g. ChipScope)
- Supports Industry-Standard Boundary Scan Testing

Configuration : USB Connector

- Allows Direct Connection to PC via Standard USB Cable
- Emulates Functionality of Xilinx Platform USB Cable
- Eliminates the Need for Dedicated Configuration Cables



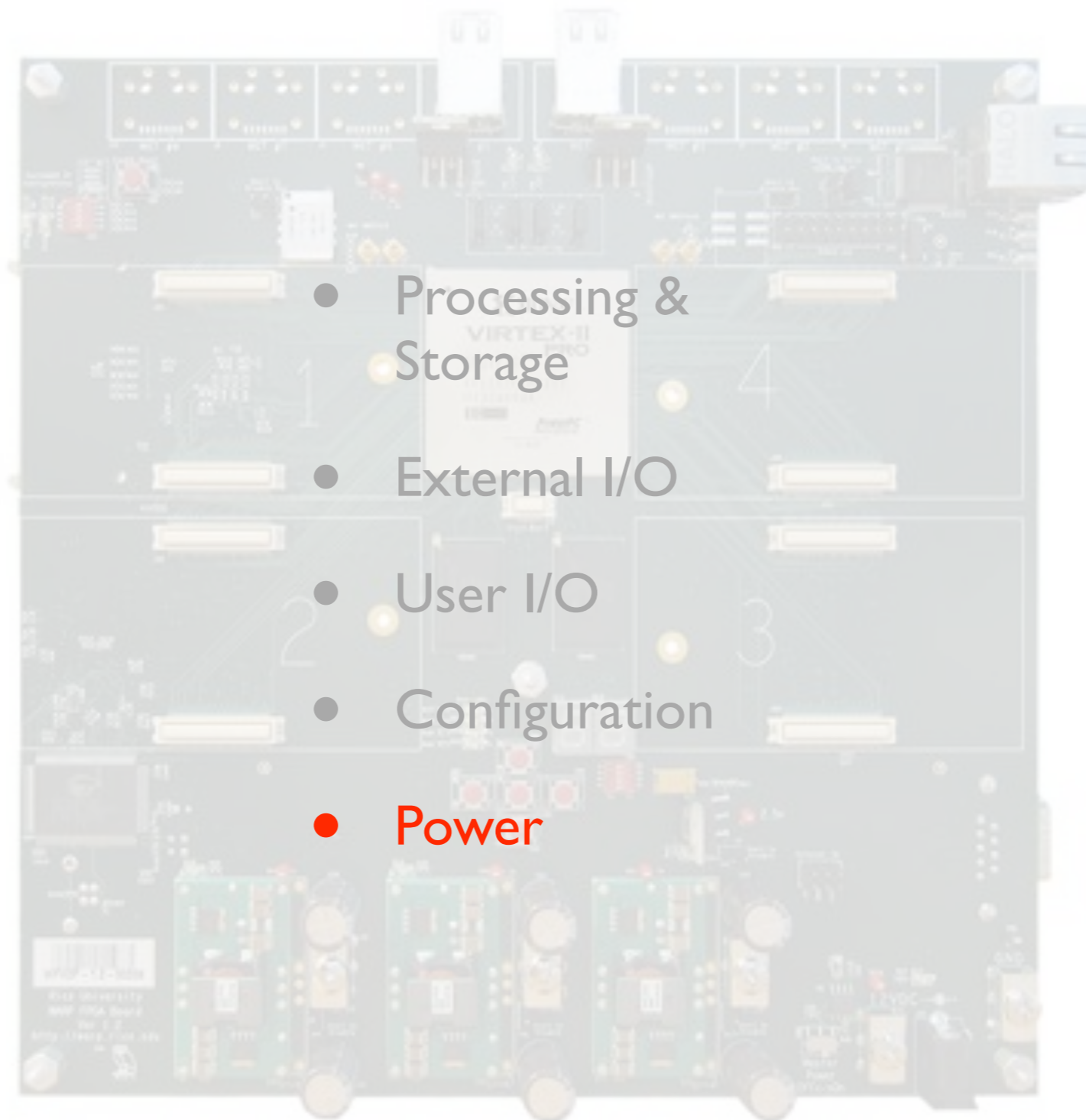

- Processing & Storage

- External I/O

- User I/O

- Configuration

- **Power**



Power : 12V DC Voltage Input

- User Supplies a Single External Voltage Supply
- All Other Required Voltages are Derived on PCB



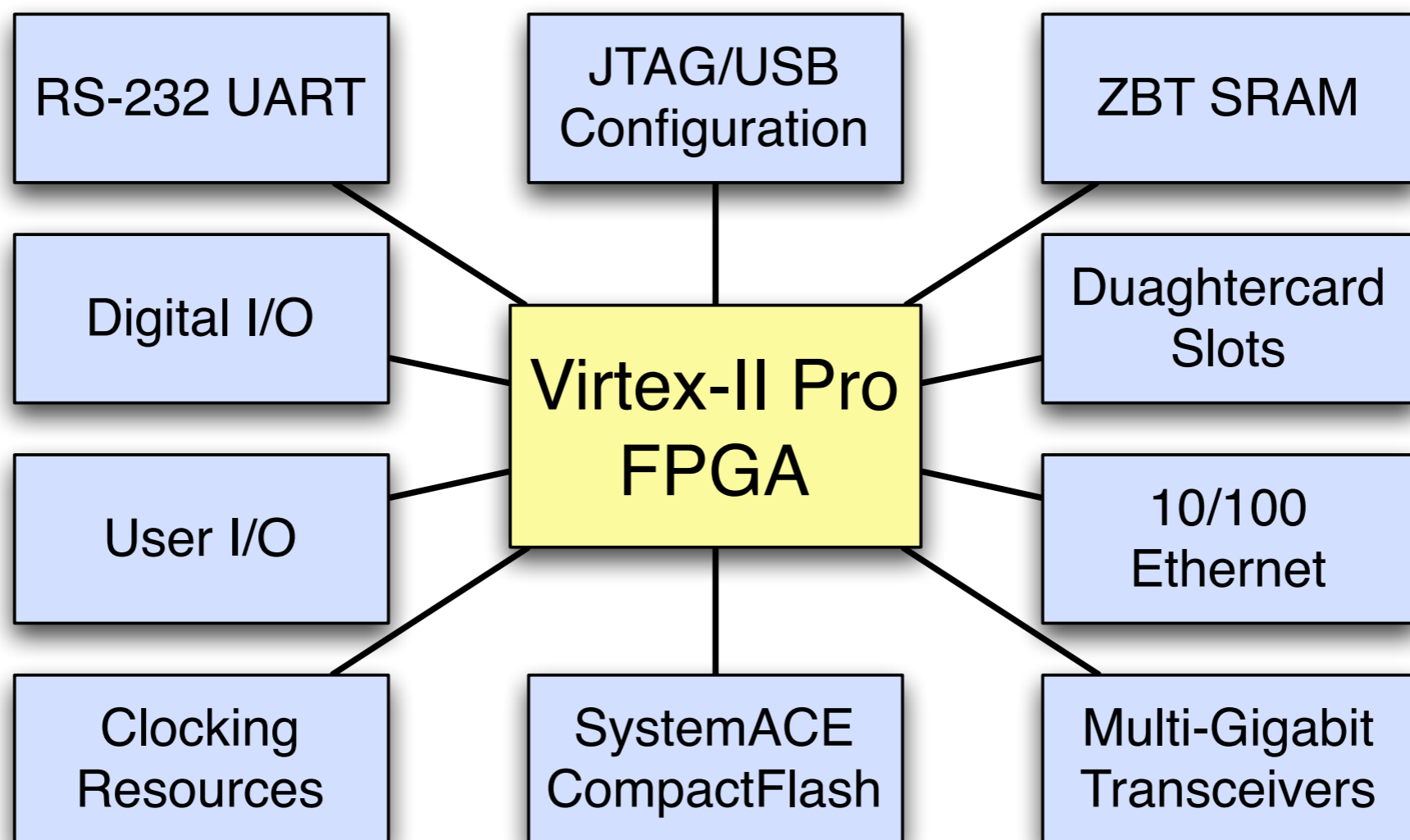

WARP Hardware

- WARP Hardware Components
 - FPGA Board
 - Radio Board
 - Clock Board
- FPGA Architecture
- WARP Design Flows

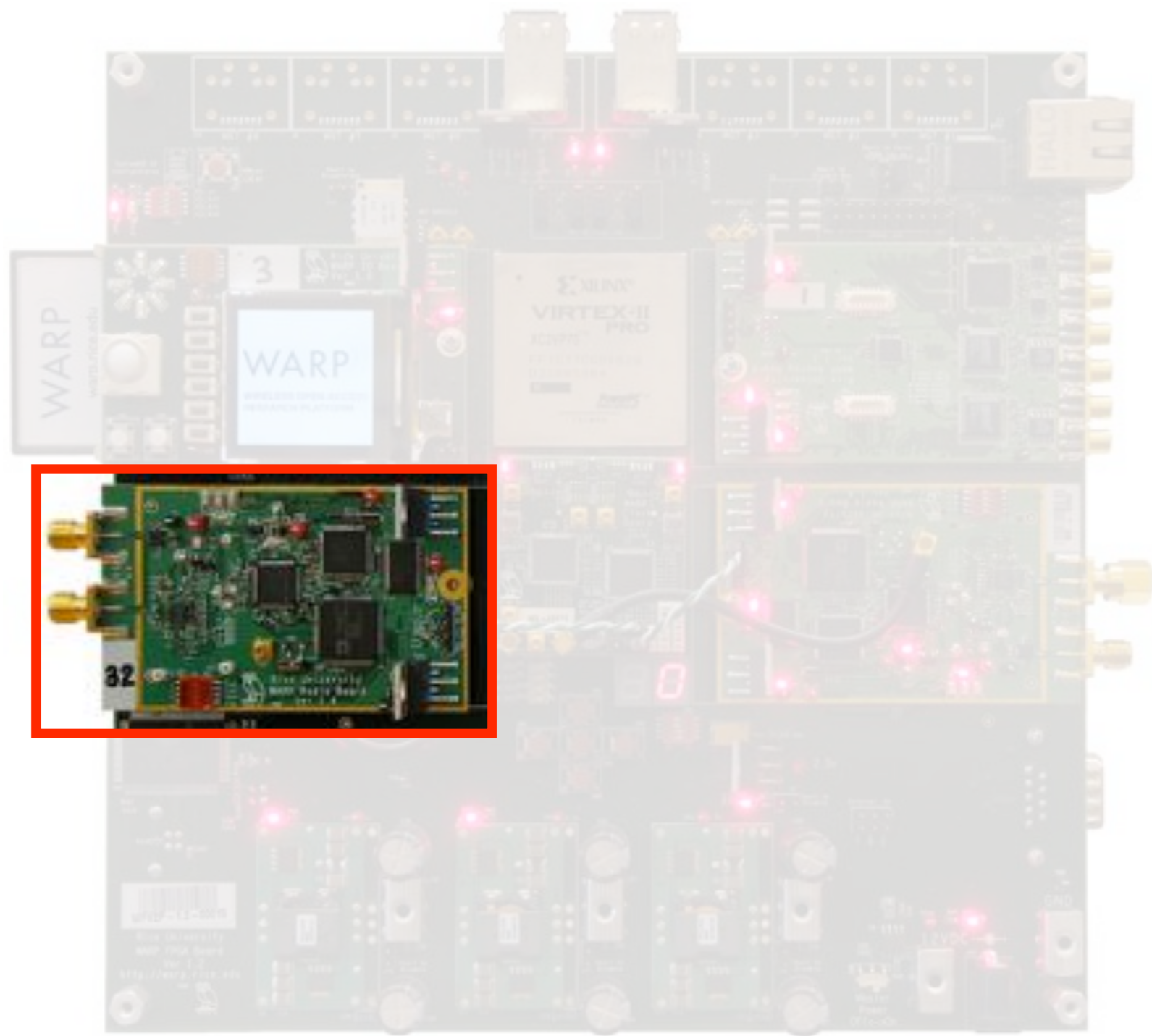

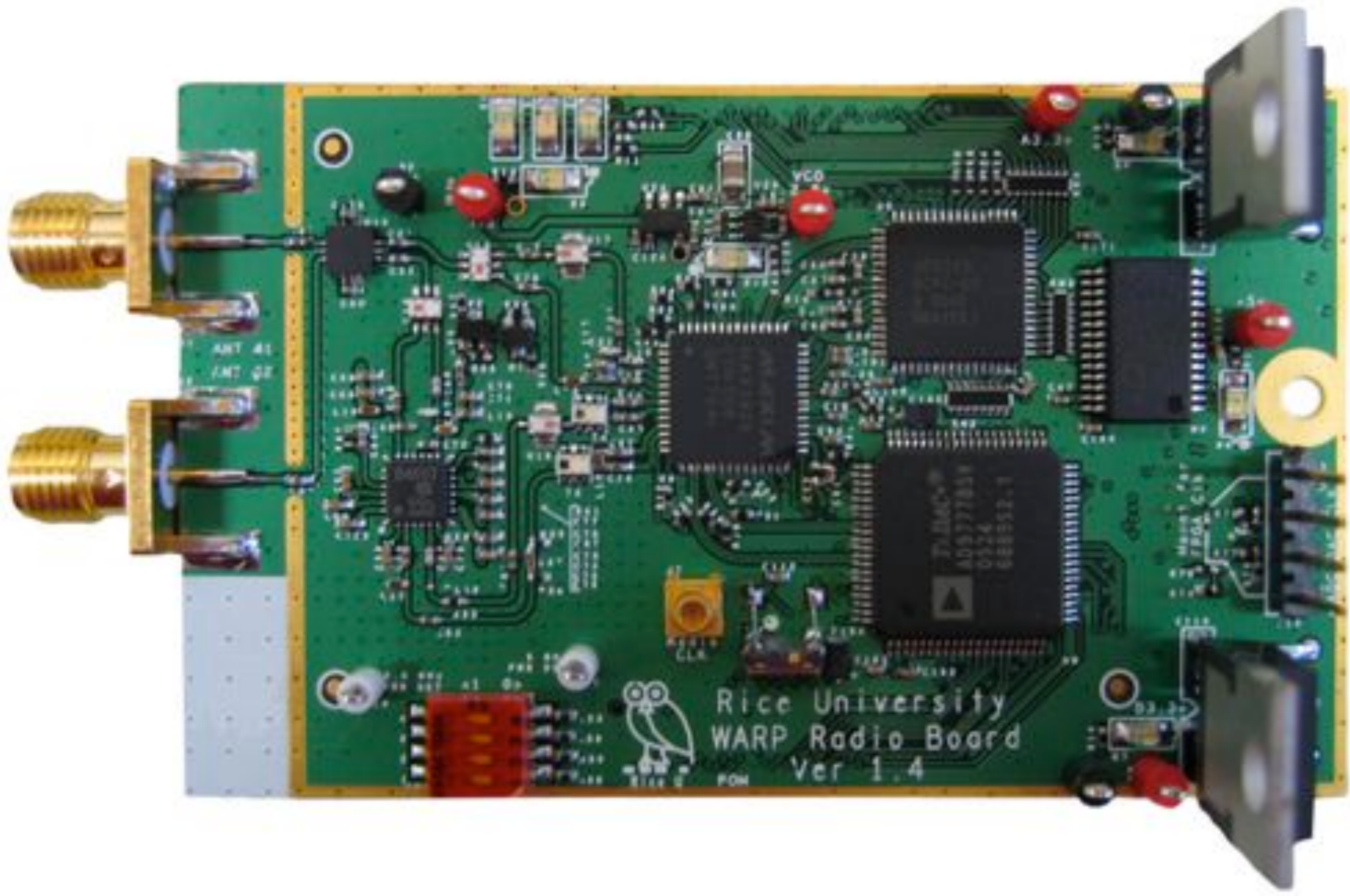

Rice University
WARP Radio Board
Ver 1.4



ANT 01
ANT 02

VCO

CLK

PROCESOR

Memory for
M3780A C18

03.3



POM

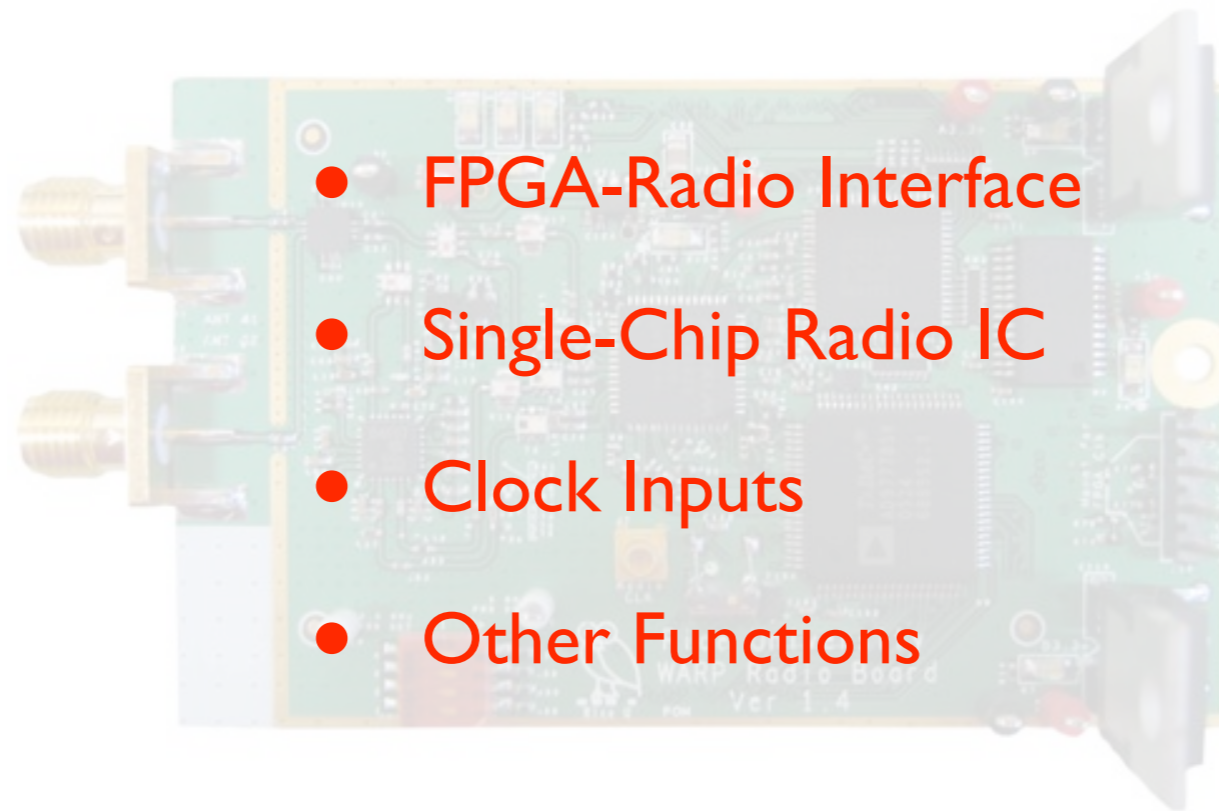

- FPGA-Radio Interface
- Single-Chip Radio IC
- Clock Inputs
- Other Functions

FPGA-Radio Interface : Transmit D/A Converters

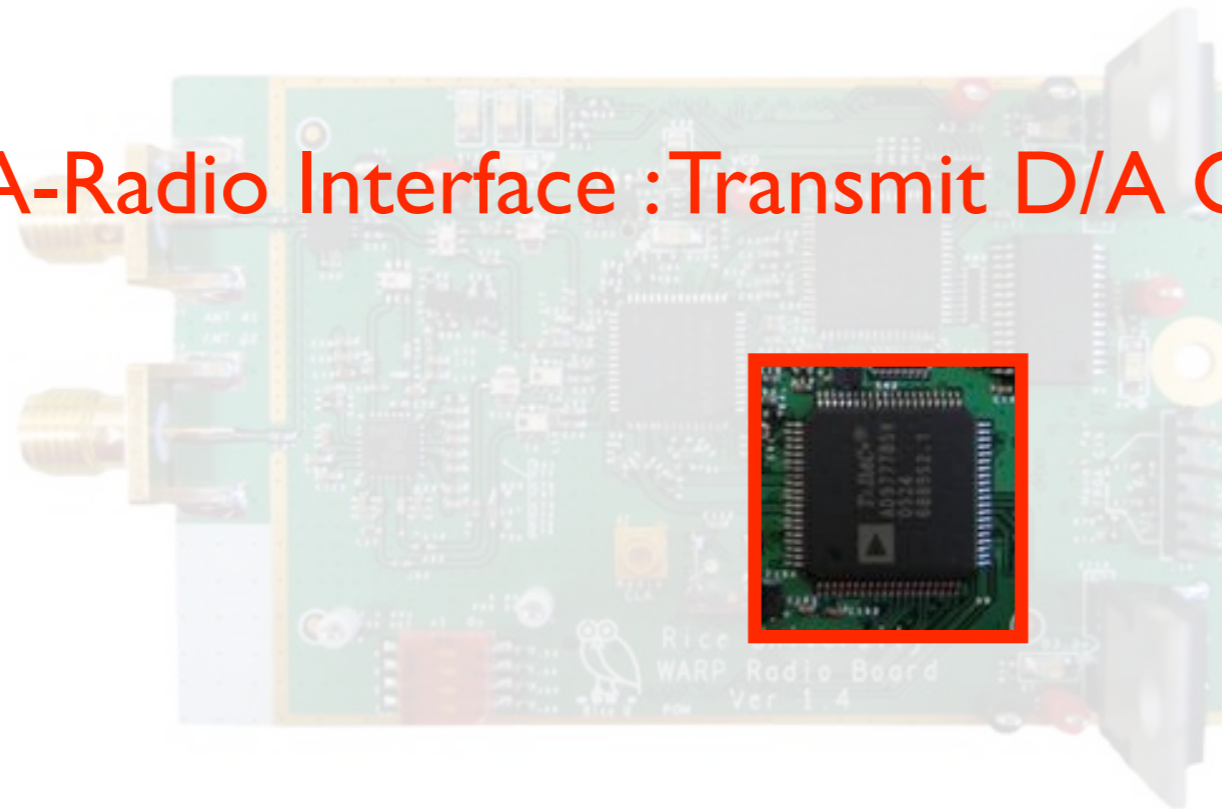

- 16-Bit I & 16-Bit Q Baseband Data
- Dual Converters for Optimum Parametric Matching

FPGA-Radio Interface : Receive A/D Converters

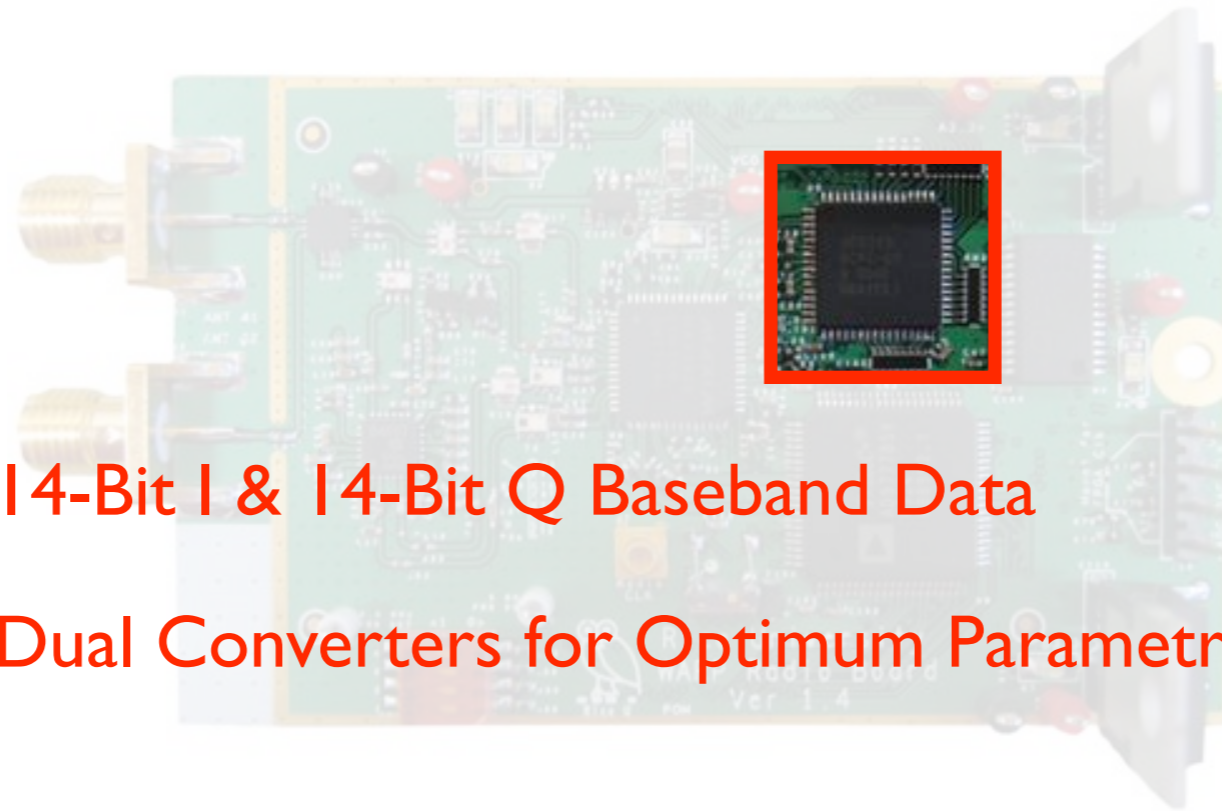

- 14-Bit I & 14-Bit Q Baseband Data
- Dual Converters for Optimum Parametric Matching

FPGA-Radio Interface : RSSI A/D Converter

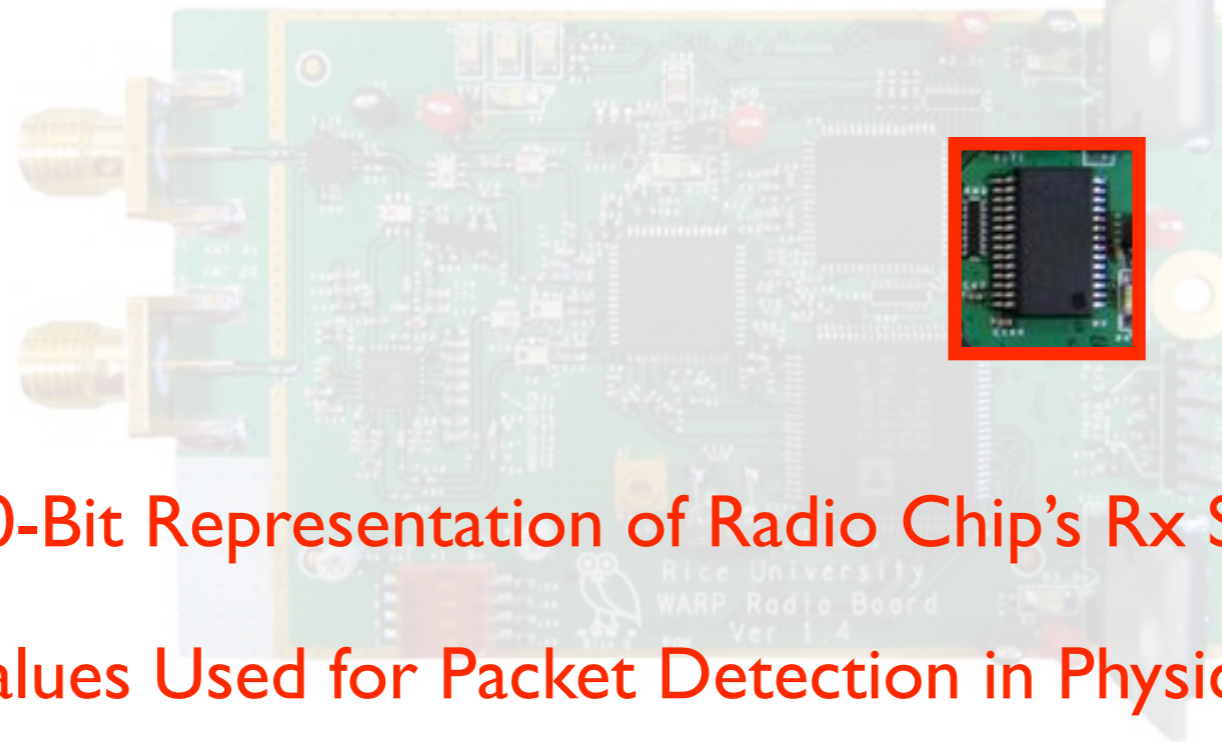

- 10-Bit Representation of Radio Chip's Rx Signal Strength
- Values Used for Packet Detection in Physical Layer

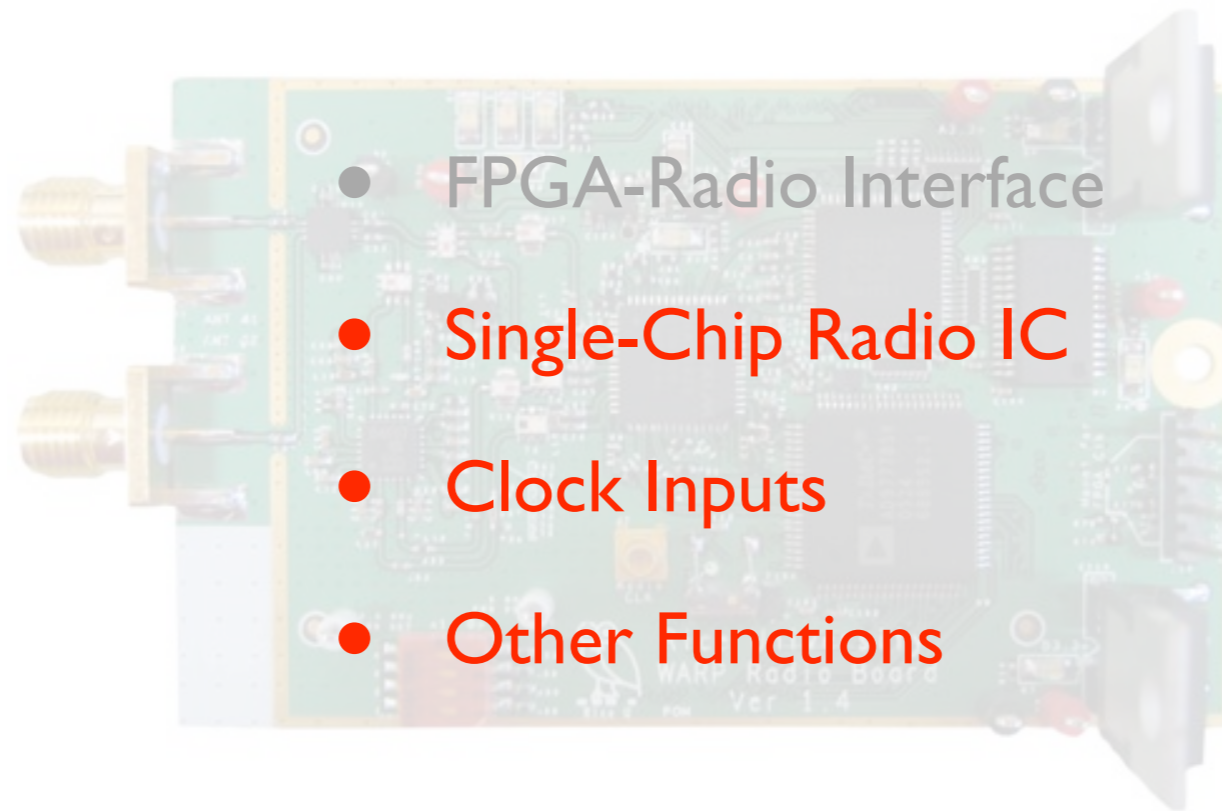

- FPGA-Radio Interface
- Single-Chip Radio IC
- Clock Inputs
- Other Functions

Single-Chip Radio IC : MAX2829

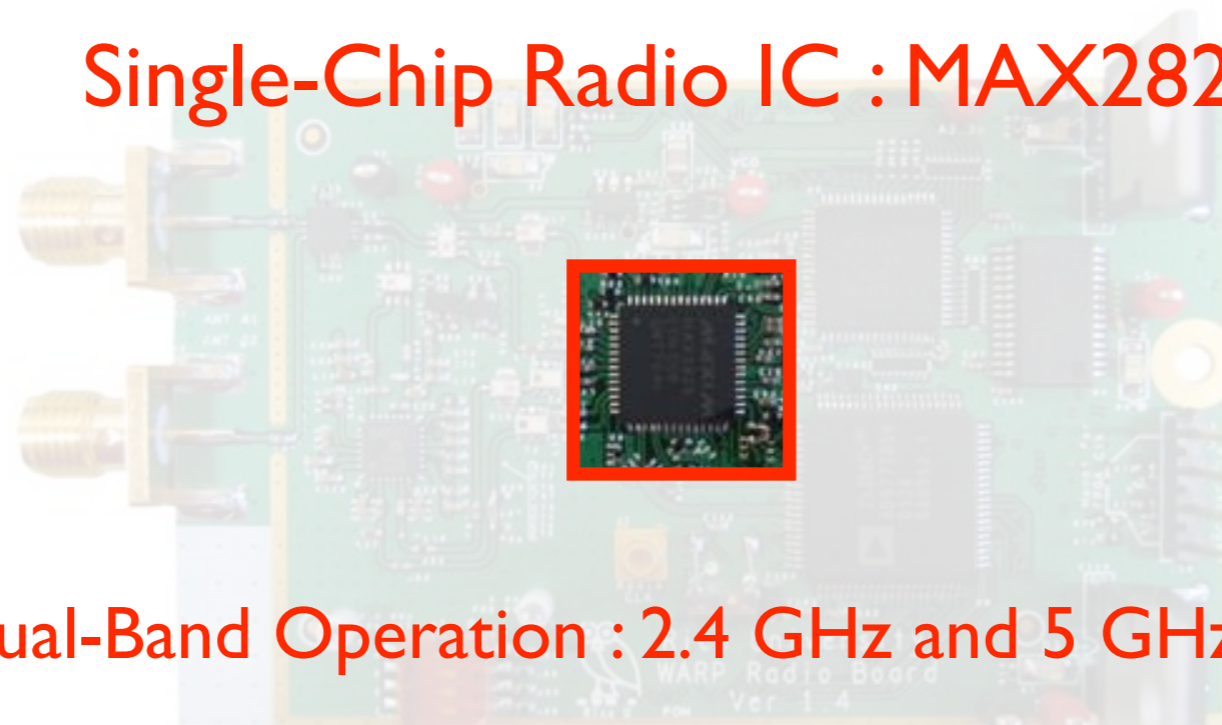

- Dual-Band Operation : 2.4 GHz and 5 GHz
- Direct Conversion Between RF and Baseband
- 40 MHz Bandwidth Independent of Carrier Frequency

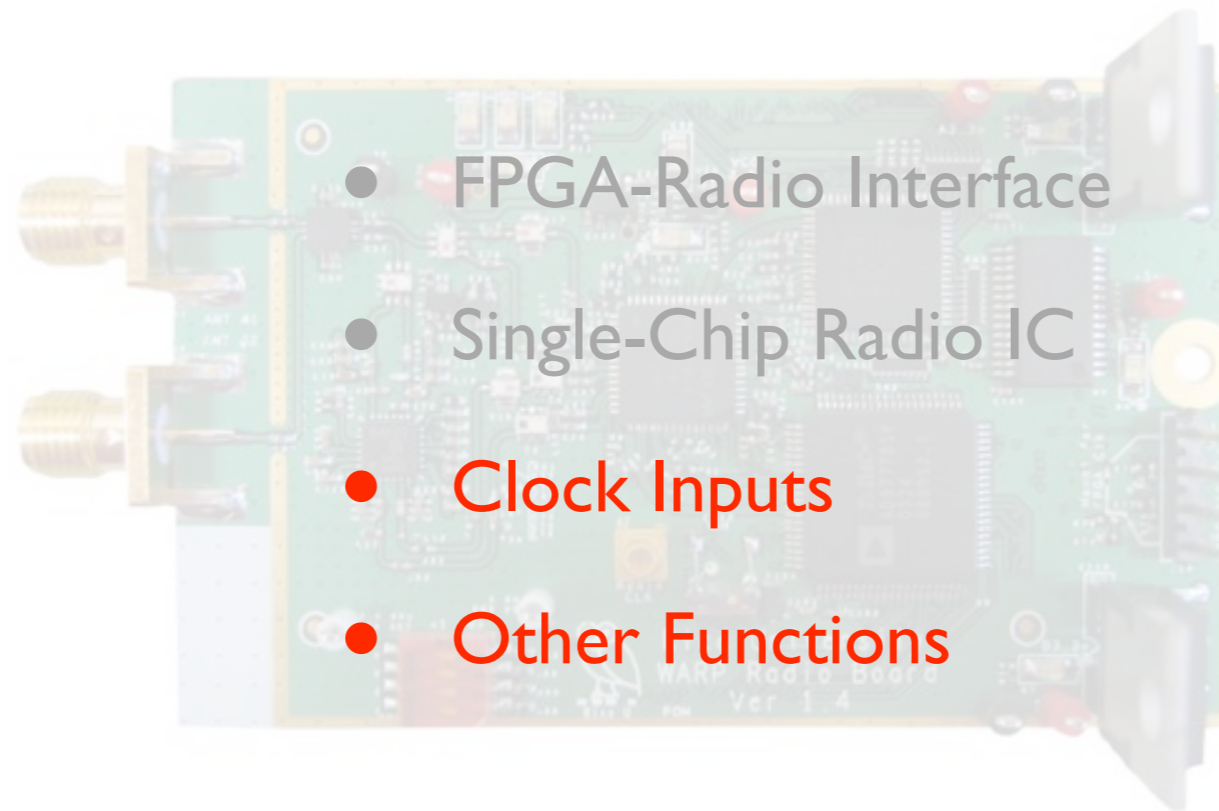

- FPGA-Radio Interface
- Single-Chip Radio IC
- **Clock Inputs**
- **Other Functions**

Clock Inputs

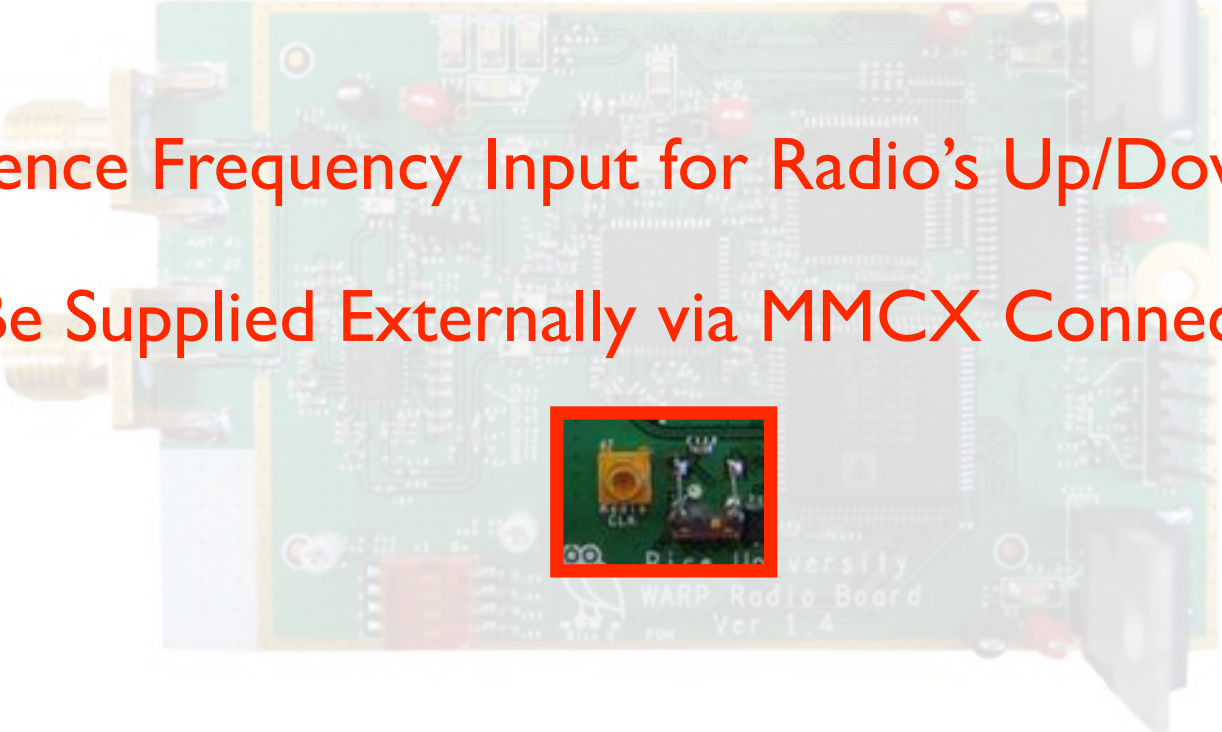
- Reference Frequency Input for Radio's Up/Down Conversion
 - May Be Supplied Externally via MMCX Connector
- 
- May Be Supplied Locally via Onboard Oscillator
 - Low-Frequency Signal is Up-Converted by Radio IC

Clock Inputs

- Reference Clock for A/D, D/A Converters
- Off-board via header or from FPGA

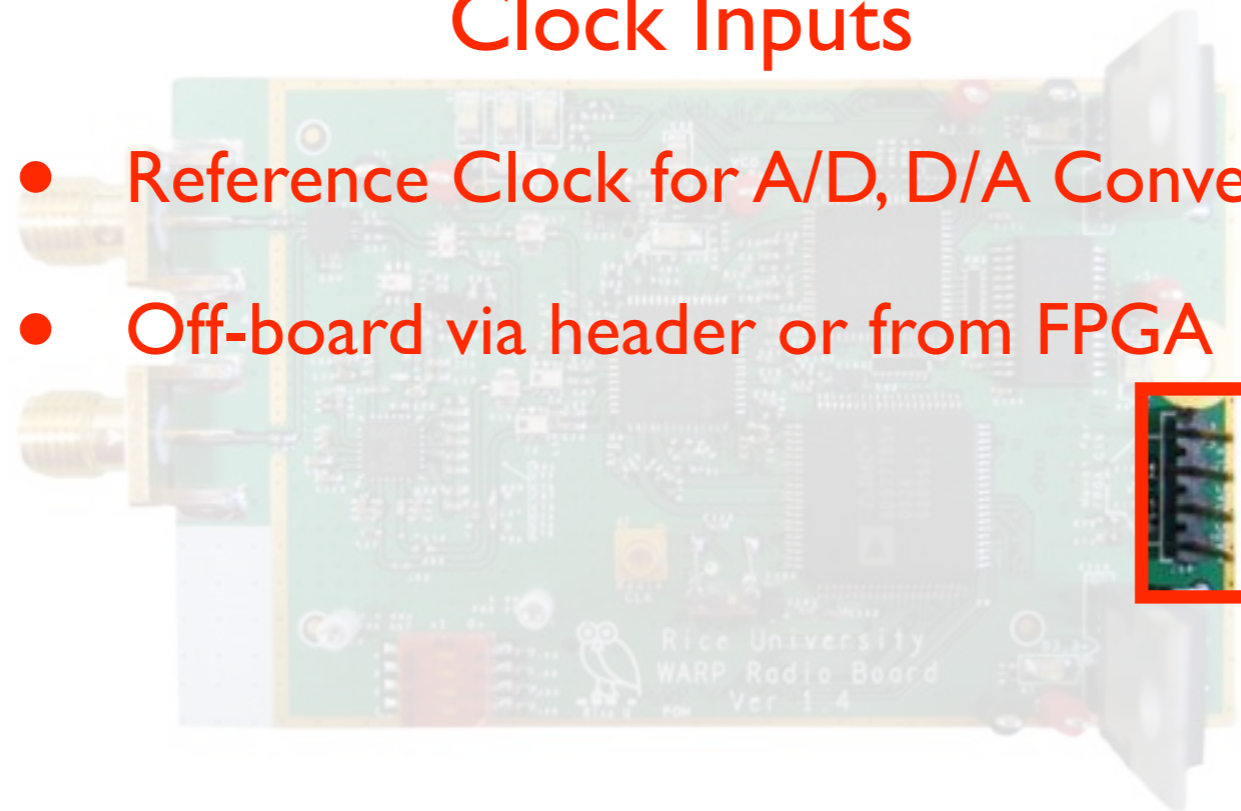

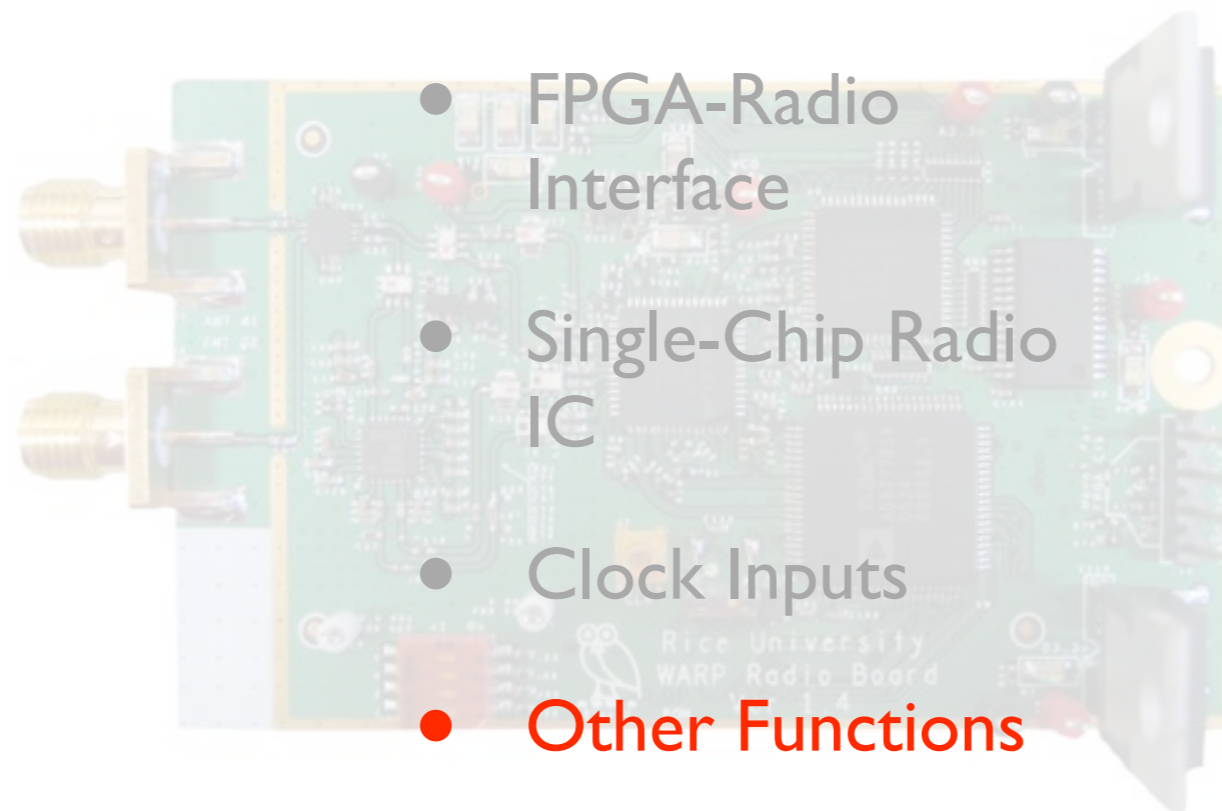

- FPGA-Radio Interface
- Single-Chip Radio IC
- Clock Inputs
- Other Functions

Other Functions : RF Front-End

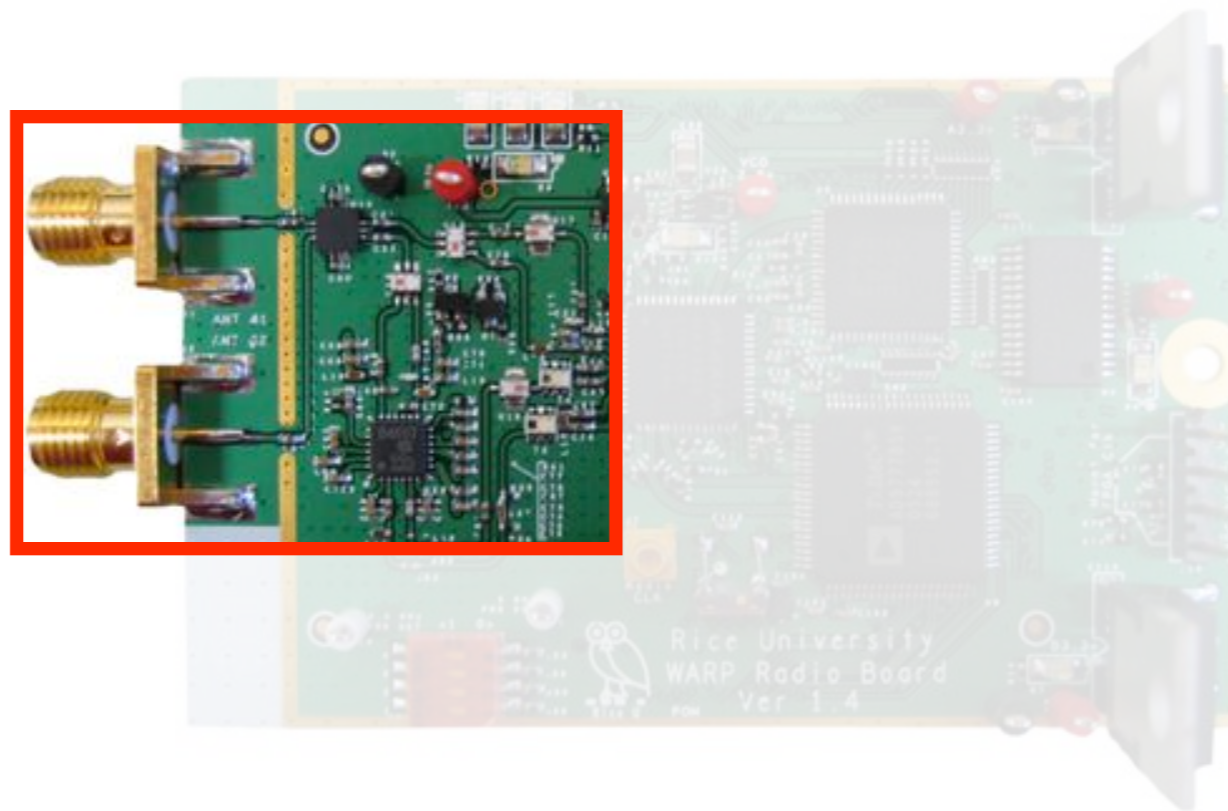

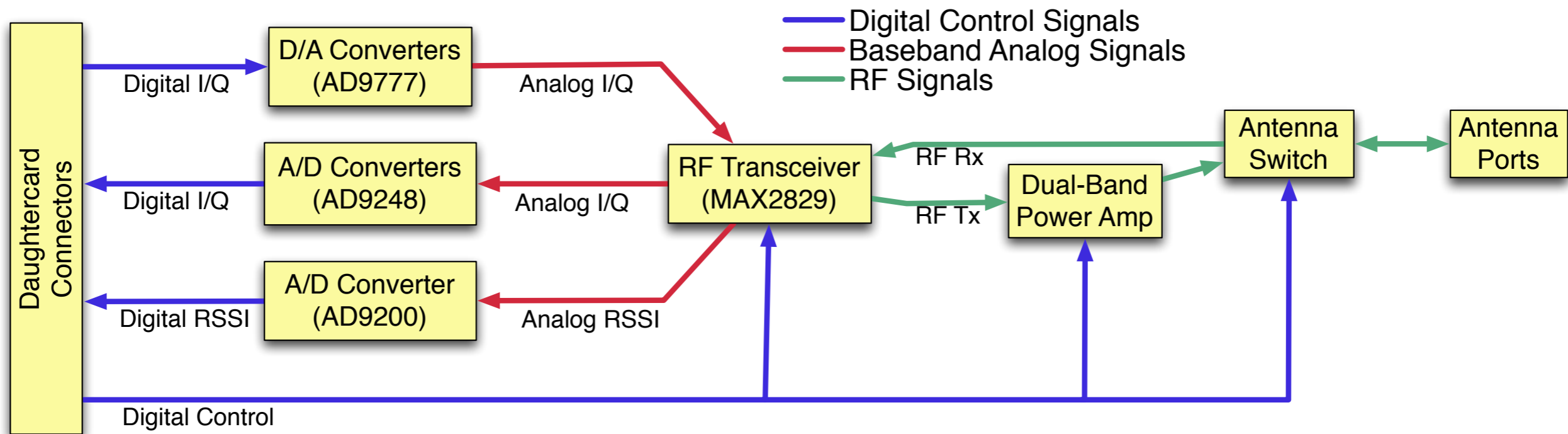

Questions?

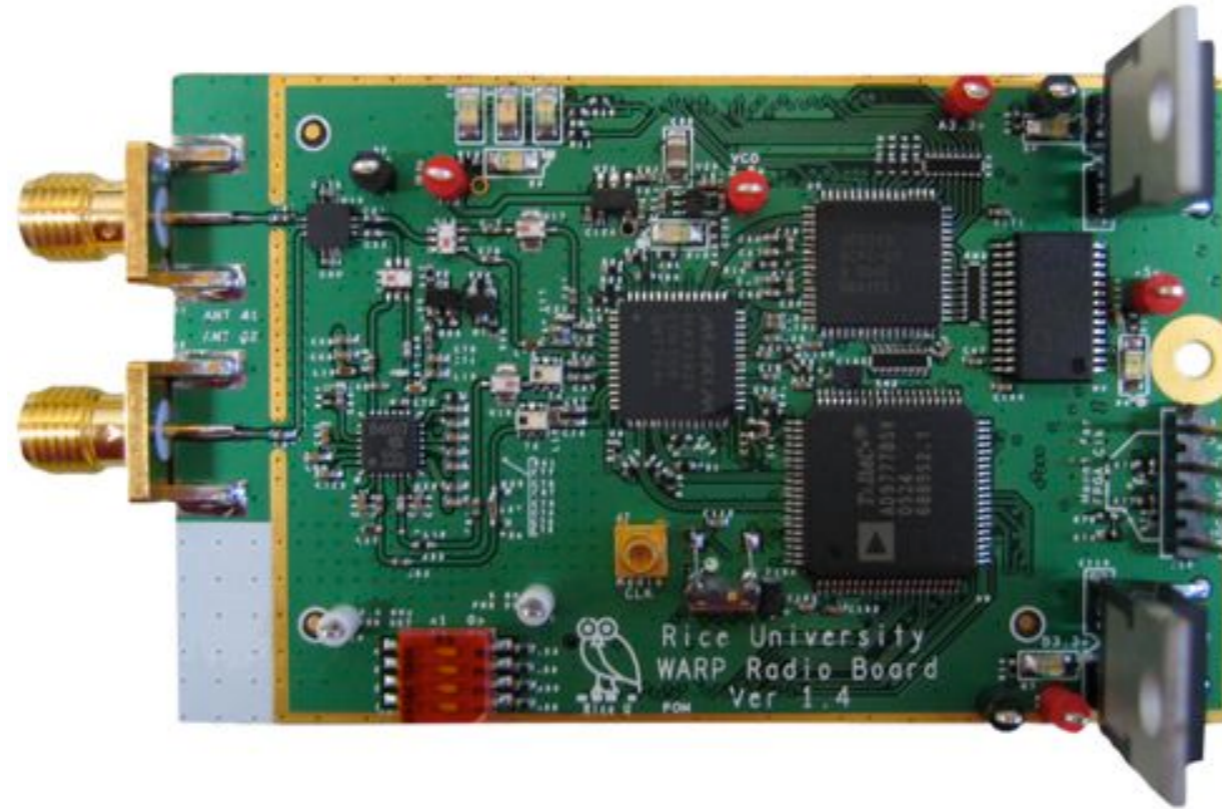

WARP Hardware

- WARP Hardware Components
 - FPGA Board
 - Radio Board
 - Clock Board
- FPGA Architecture
- WARP Design Flows

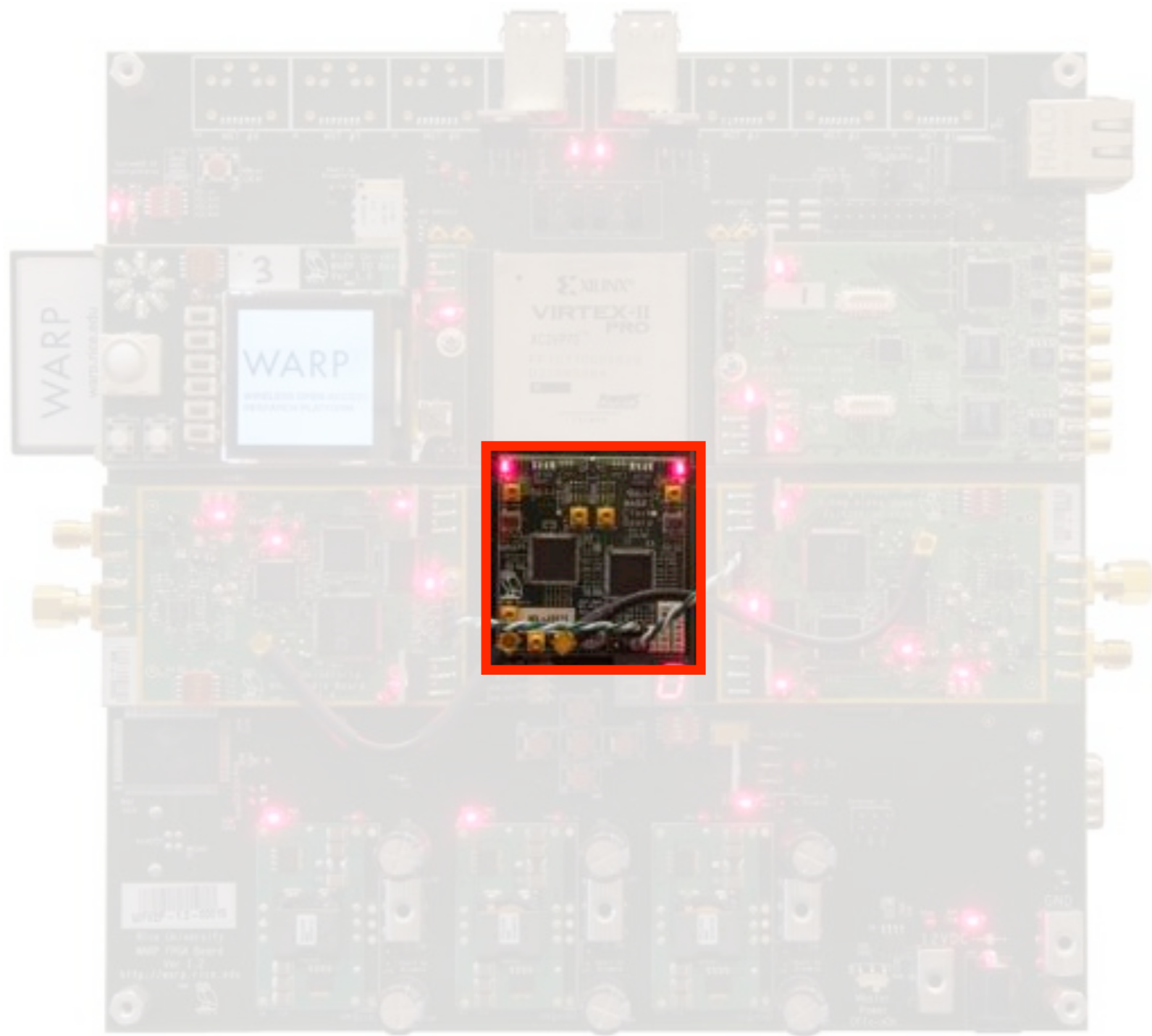

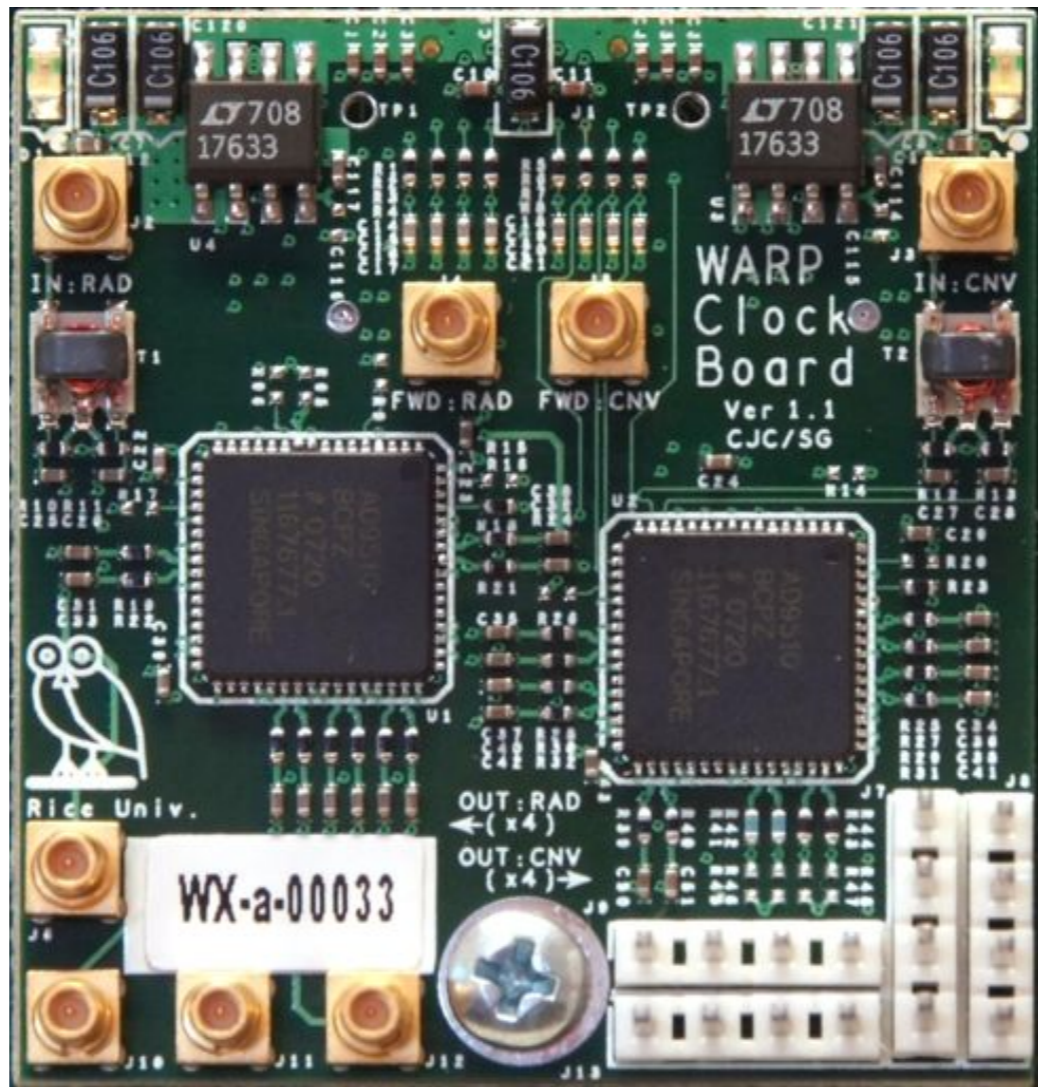



Radio Reference Clock

- 20 MHz Output
- High-Precision Oscillator



External Input

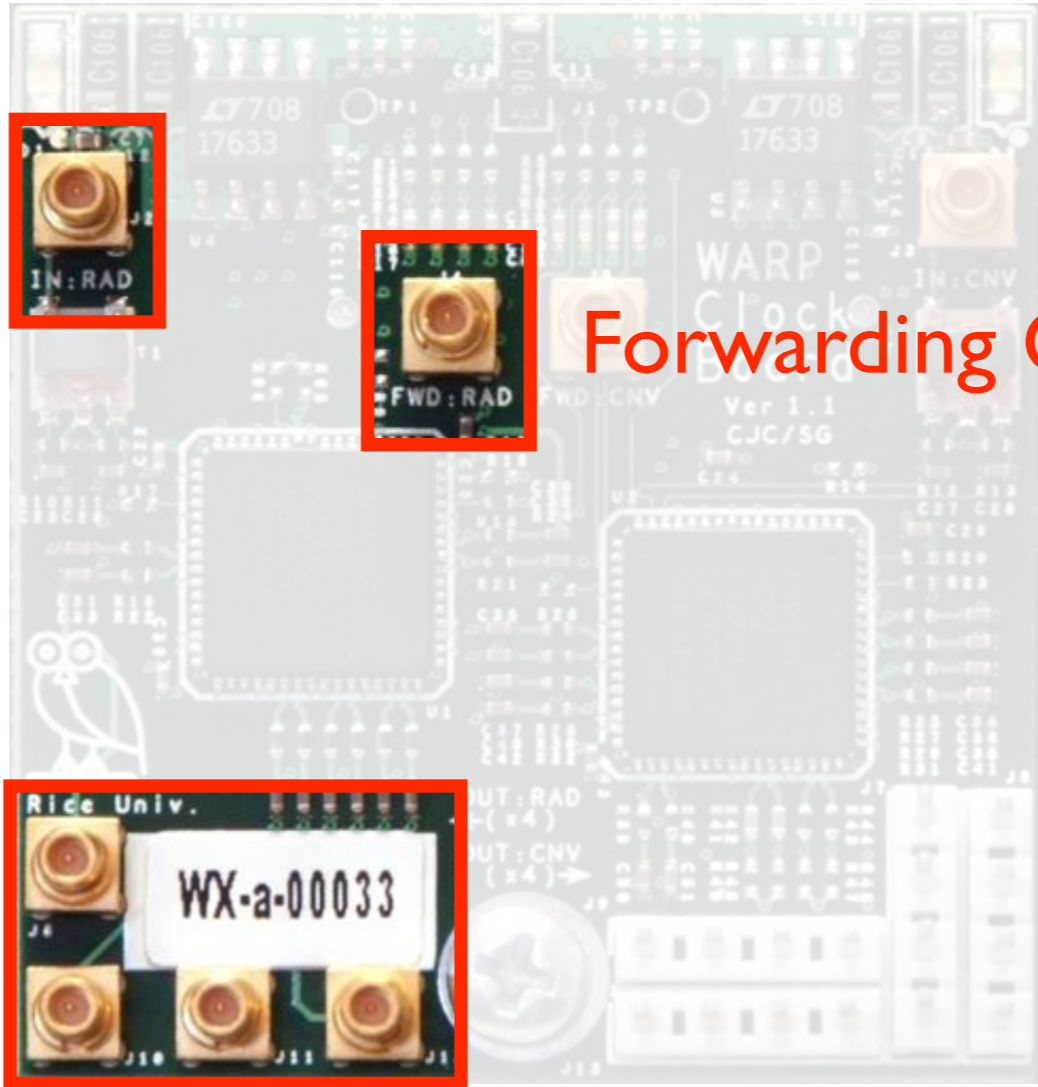

Forwarding Output

Four MMCX
Daughtercard Outputs

Radio Clock

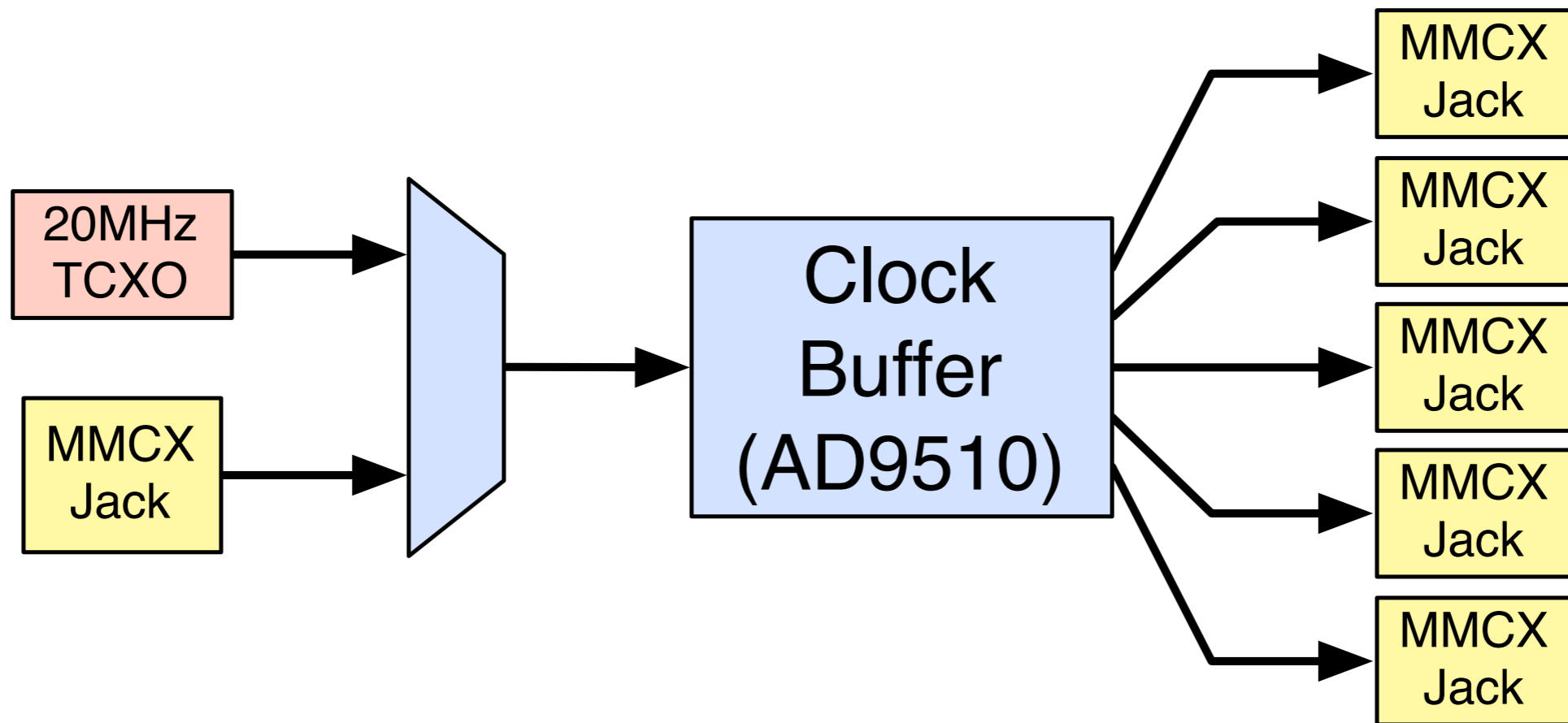

FPGA Logic Clock

- 40MHz Output
- Clocks FPGA and Radio Data

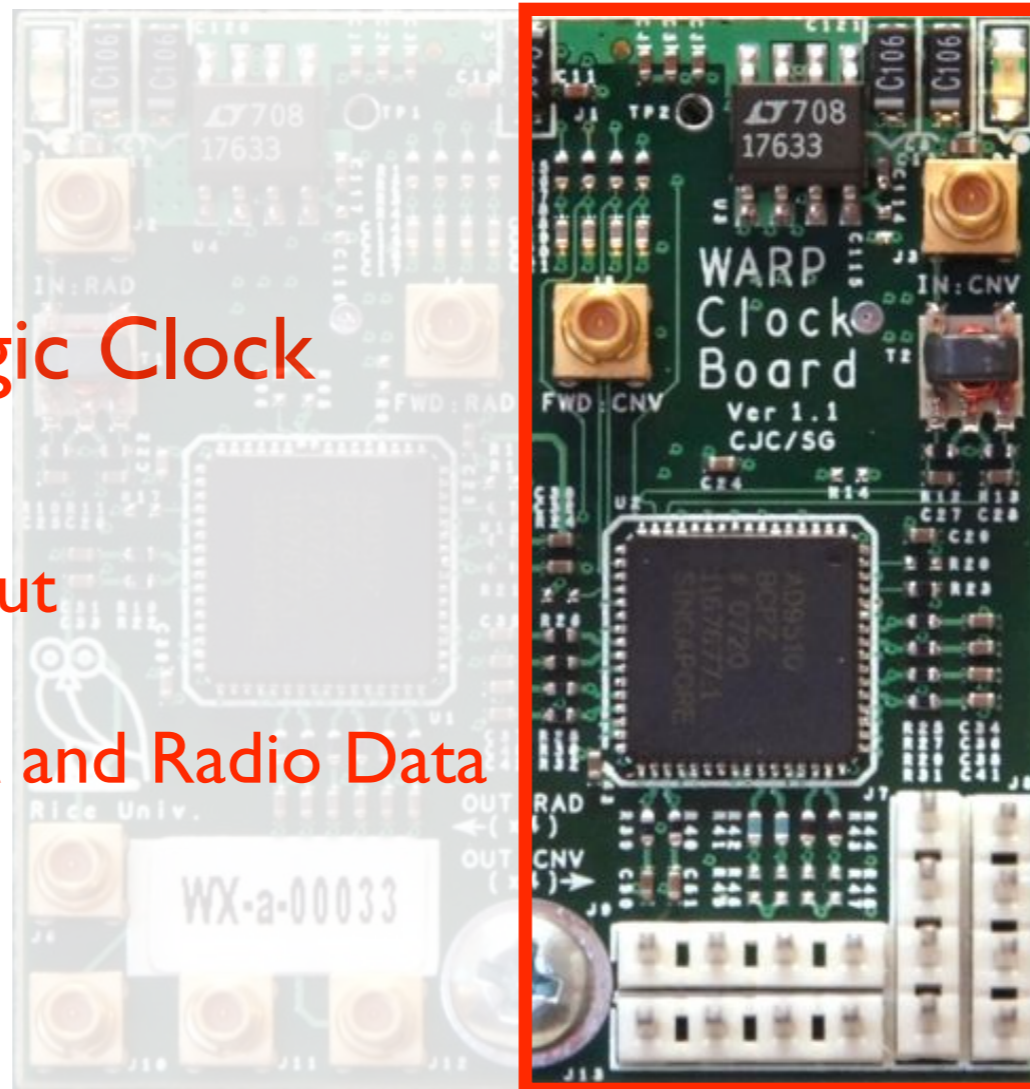

Forwarding Output



External Input

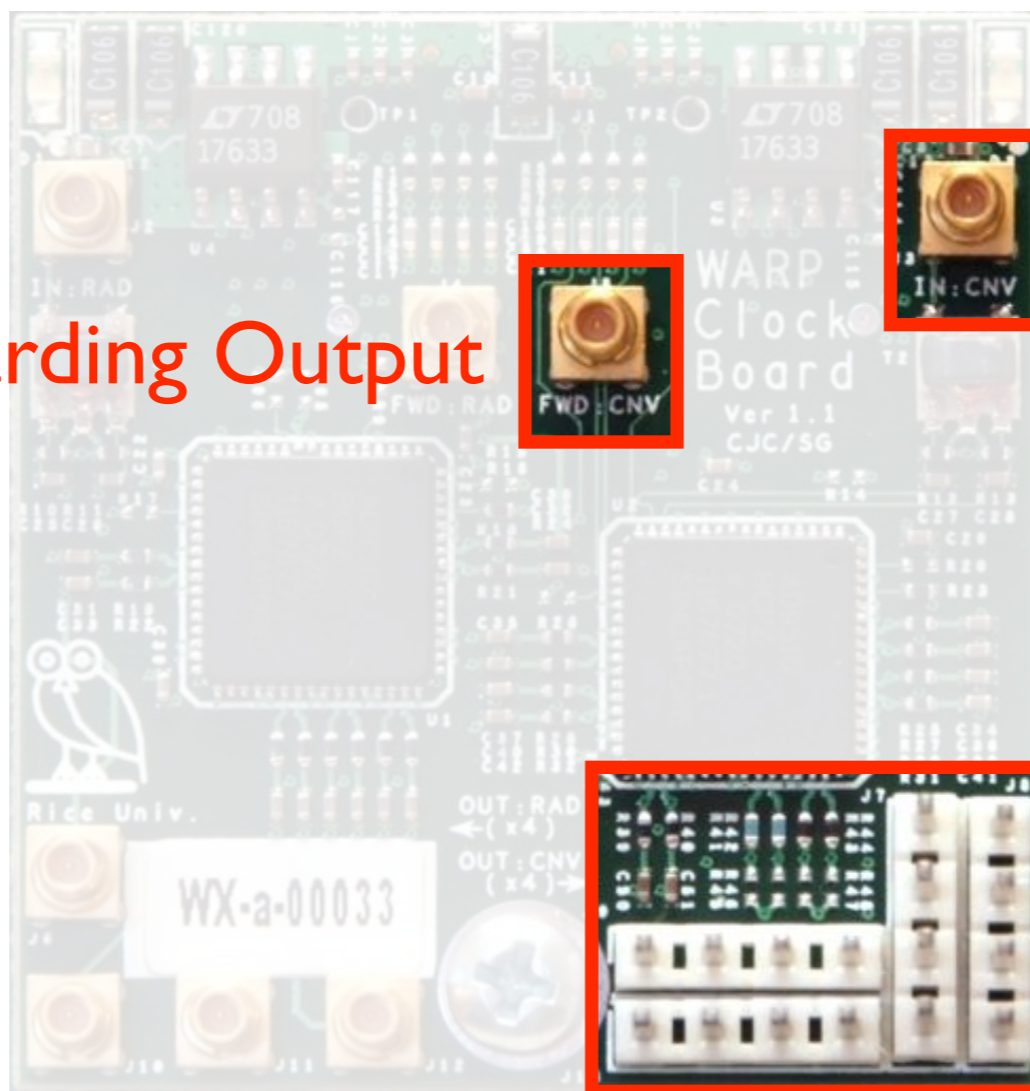

Four Twisted-Pair
Daughtercard Outputs

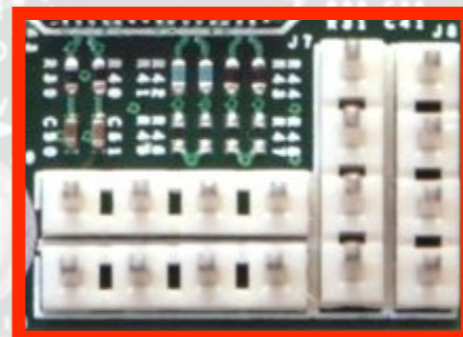

Logic Clock

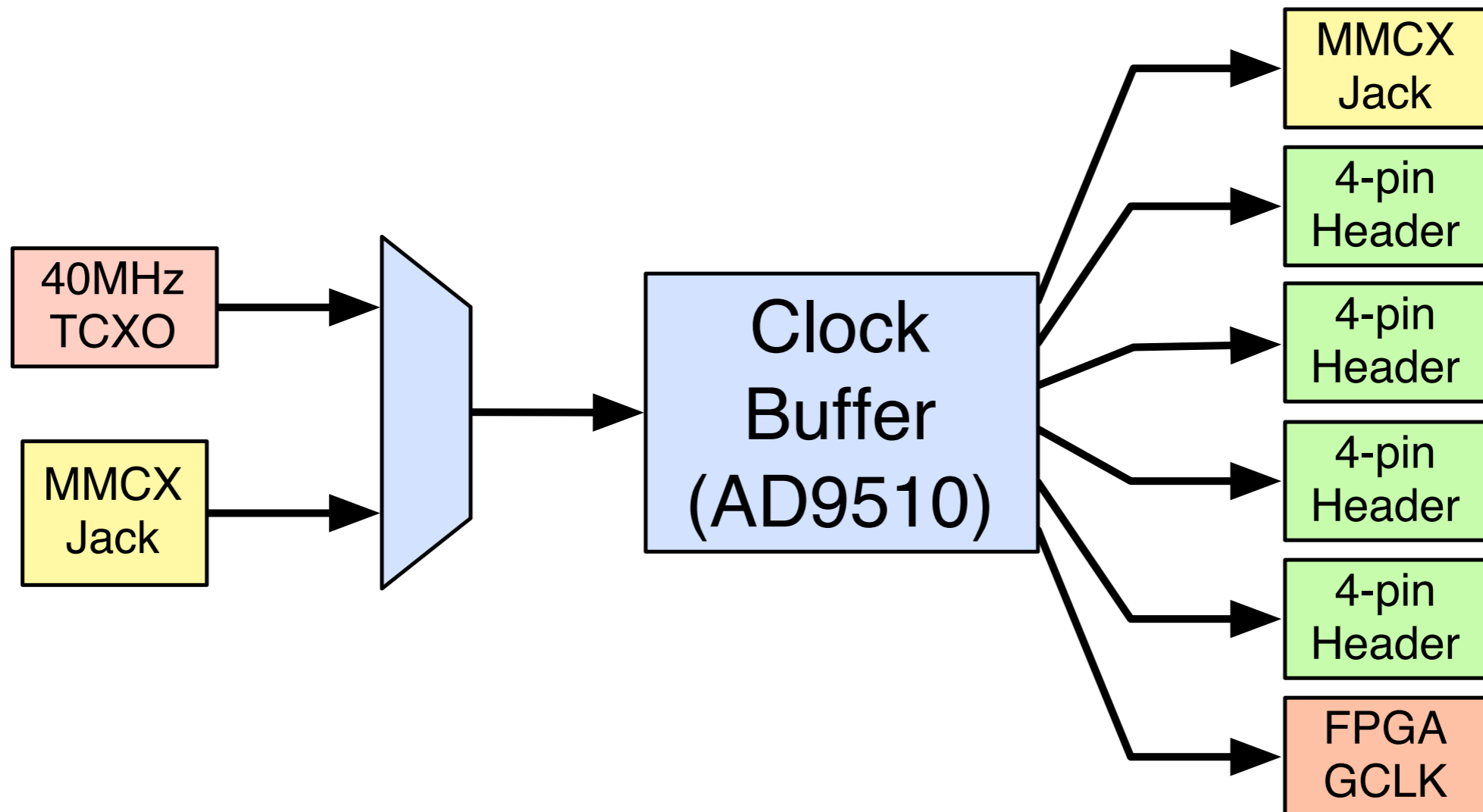

Questions?



WARP Hardware

- WARP Hardware Components
 - FPGA Board
 - Radio Board
 - Clock Board
- **FPGA Architecture**
- **WARP Design Flows**

XC2VP70 Internal Resources



XC2VP70 Resources

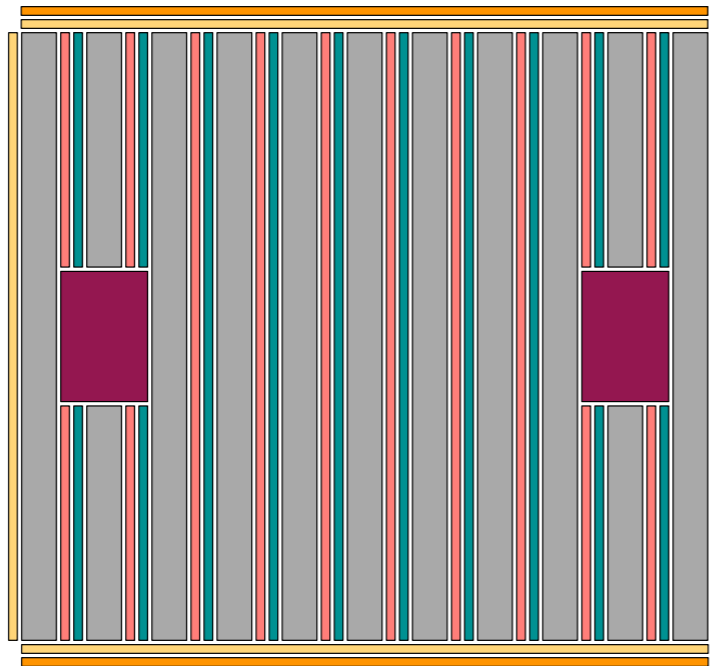

- Embedded PowerPC processors
- 18-Bit by 18-Bit multipliers
- 18 Kbit block RAMs
- General purpose I/Os
- Multi-gigabit transceivers (MGTs)
- Reconfigurable user logic (Fabric)

Embedded PowerPCs

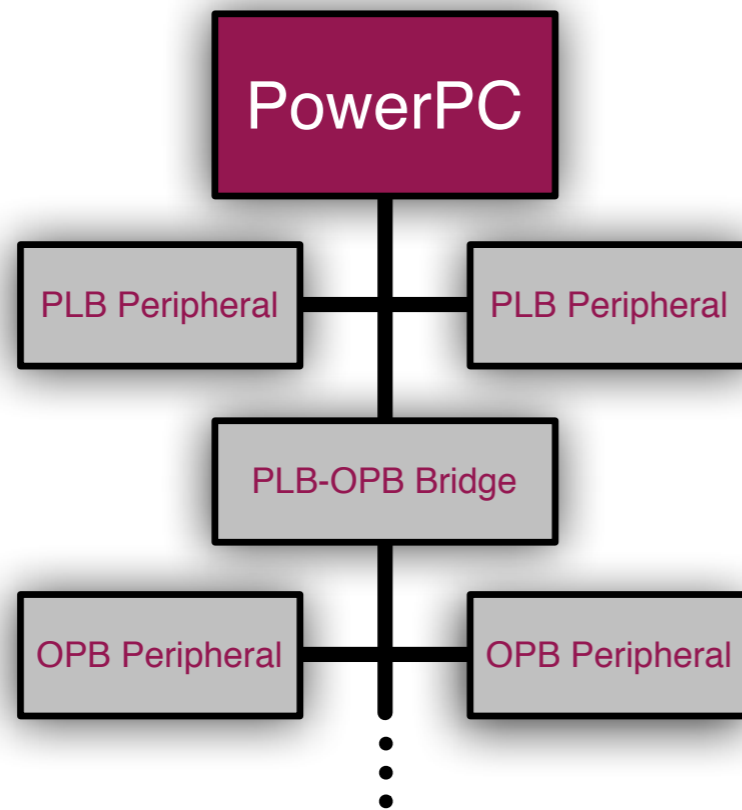

- PPCs connect to peripherals through the IBM Processor Local Bus (PLB)
- Alternative connections via the simpler On-Chip Peripheral Bus (OPB)
- PPCs execute user software for high-level control and data processing
- WARP tools simplify implementation of custom OPB-compliant peripheral cores

18-Bit x 18-Bit Multipliers

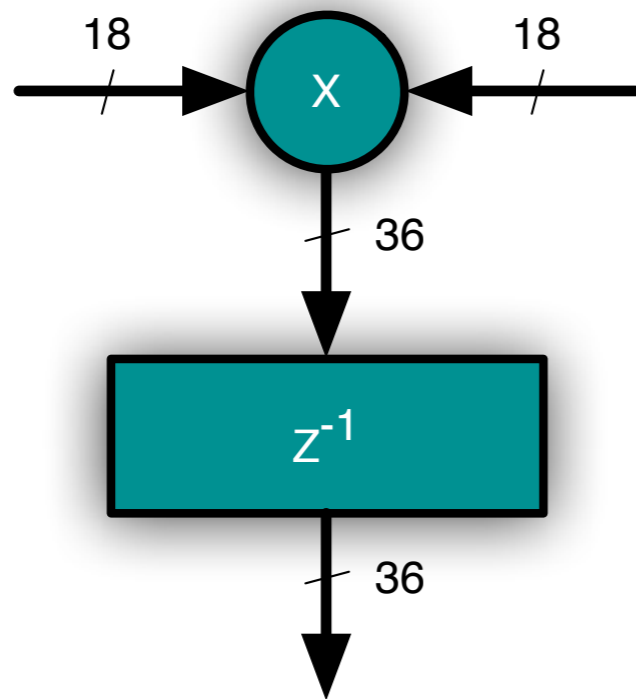

- Signed fixed-point inputs and outputs
- Fully synchronous operation with one result per clock cycle
- Tightly coupled with embedded block RAMs for very high throughput
- Operate independently and in parallel
- May be combined to support larger operands and results

18 Kbit Block RAMs

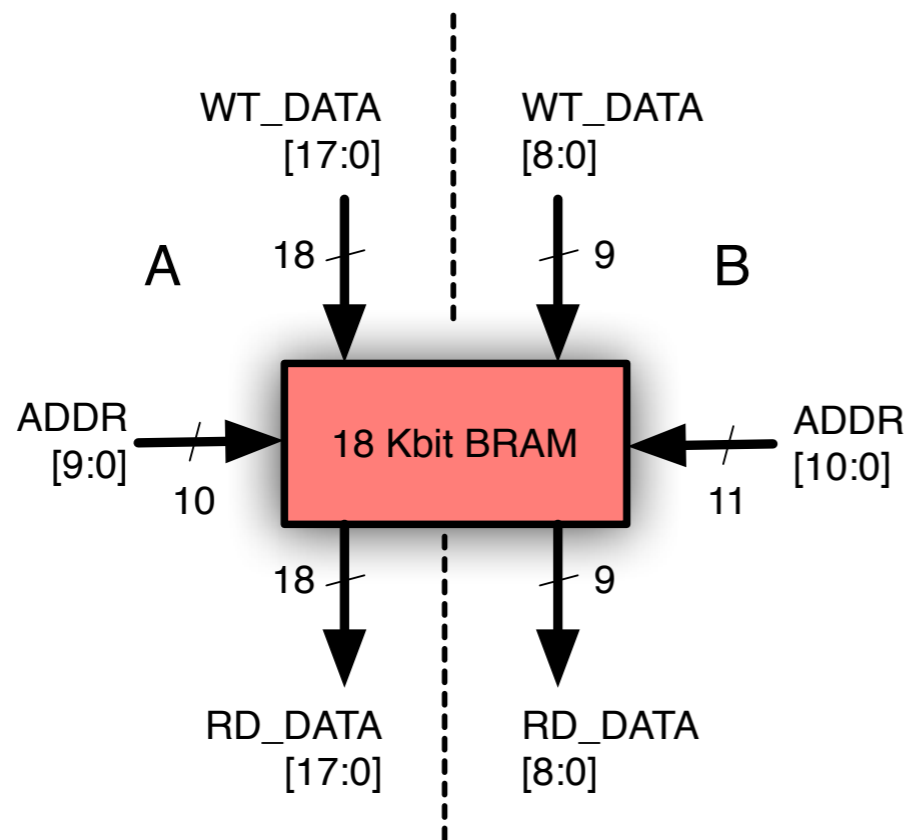

- Dual-ported for simultaneous reads and writes
- Simplifies construction of dual-port FIFOs
- Addressable via different aspect ratio on each port
- Coupled one-to-one with multipliers for extremely high throughput
- Operate independently and in parallel
- May be combined for increased capacity

Multi-Gbit Transceivers

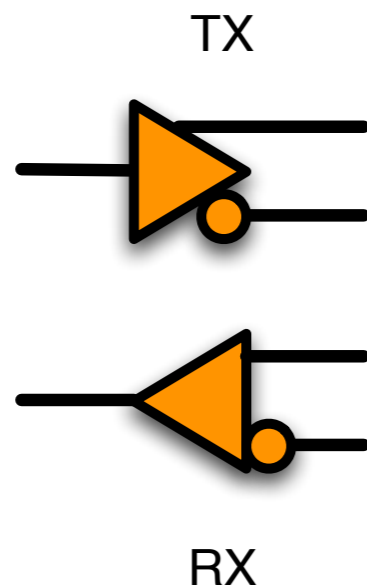

- High-speed serial links : 622 Mbps up to 3.125 Gbps
- Implement Physical Media Attachment and Physical Coding sublayers
- Perform 8b/10b encoding and decoding
- Clock and data recovered from received data stream
- Usable in low latency mode when clocks are matched at Tx and Rx

User Logic (FPGA Fabric)

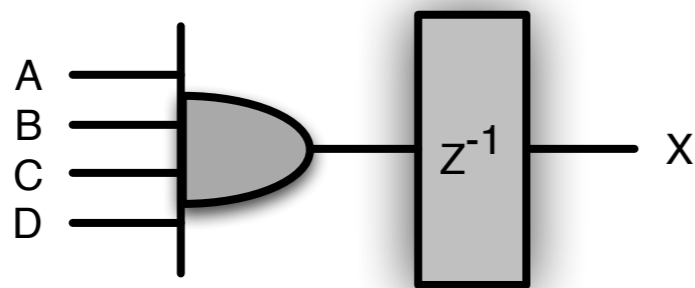

- Fine-grained array of reconfigurable logic based on 4-input LUTs
- Distributed throughout device
- Interspersed with discrete flip-flops for efficient implementation of registered logic
- Implements general purpose user functionality (e.g. WARP OFDM transceivers)
- Glues together and enhances dedicated cores within the FPGA

XC2VP70 Resources

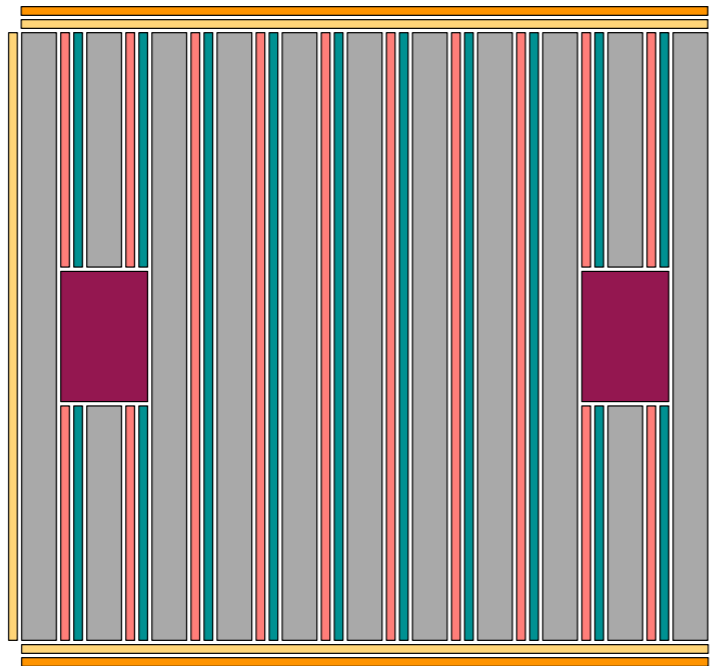

- 2 PowerPC processors
- 328 multipliers
- 328 block RAMs
- 964 general purpose I/Os
- 16 MGTs (8 on WARP FPGA board)
- 66176 4-input LUTs
- 66176 flip-flops (plus I/O registers)

Questions?

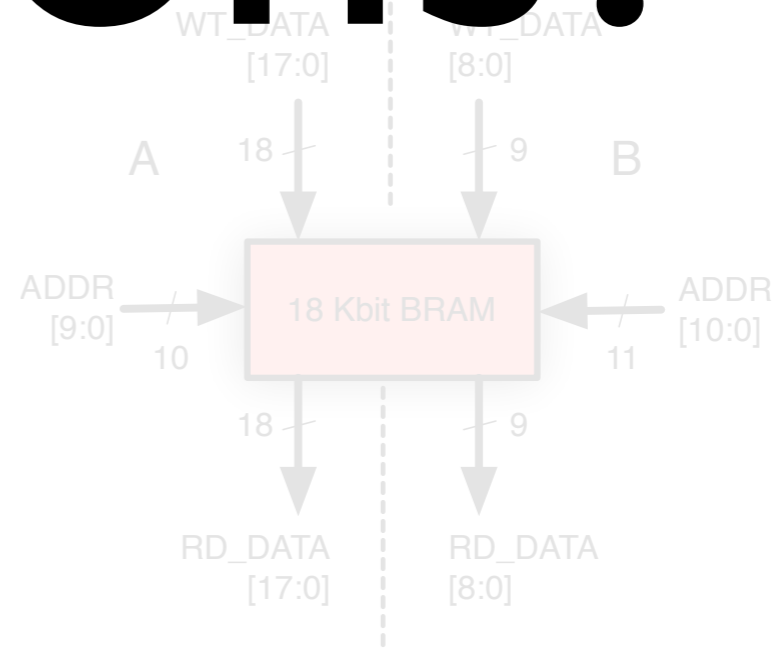
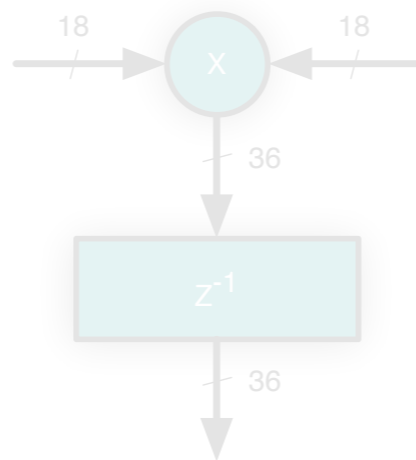
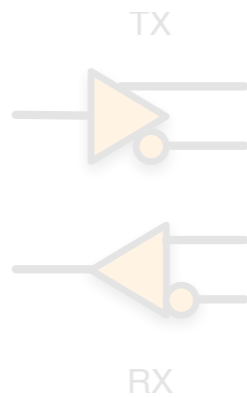
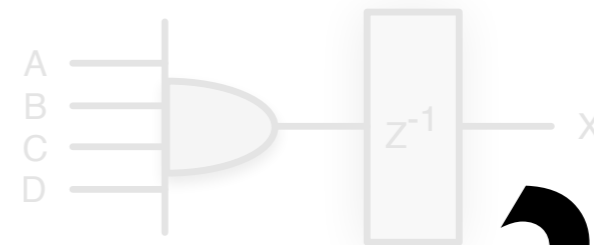
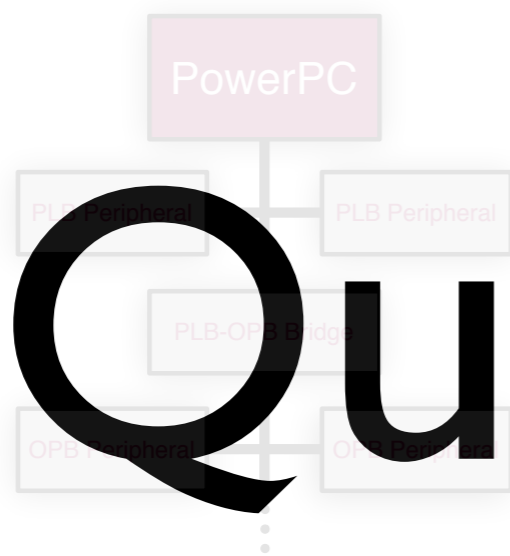

WARP Hardware

- WARP Hardware Components
 - FPGA Board
 - Radio Board
 - Clock Board
- FPGA Architecture
- **WARP Design Flows**

Targeting WARP Hardware

(Classifying Applications by Development Space)

MAC/ROUTING LAYER RESEARCH APPS.

PHYSICAL LAYER RESEARCH APPS.

ARCHITECTURE LAYER RESEARCH APPS.

S/W DEVELOPMENT
SPACE

H/W DEVELOPMENT
SPACE



Targeting WARP Hardware

(Classifying FPGA Resources by Development Space)

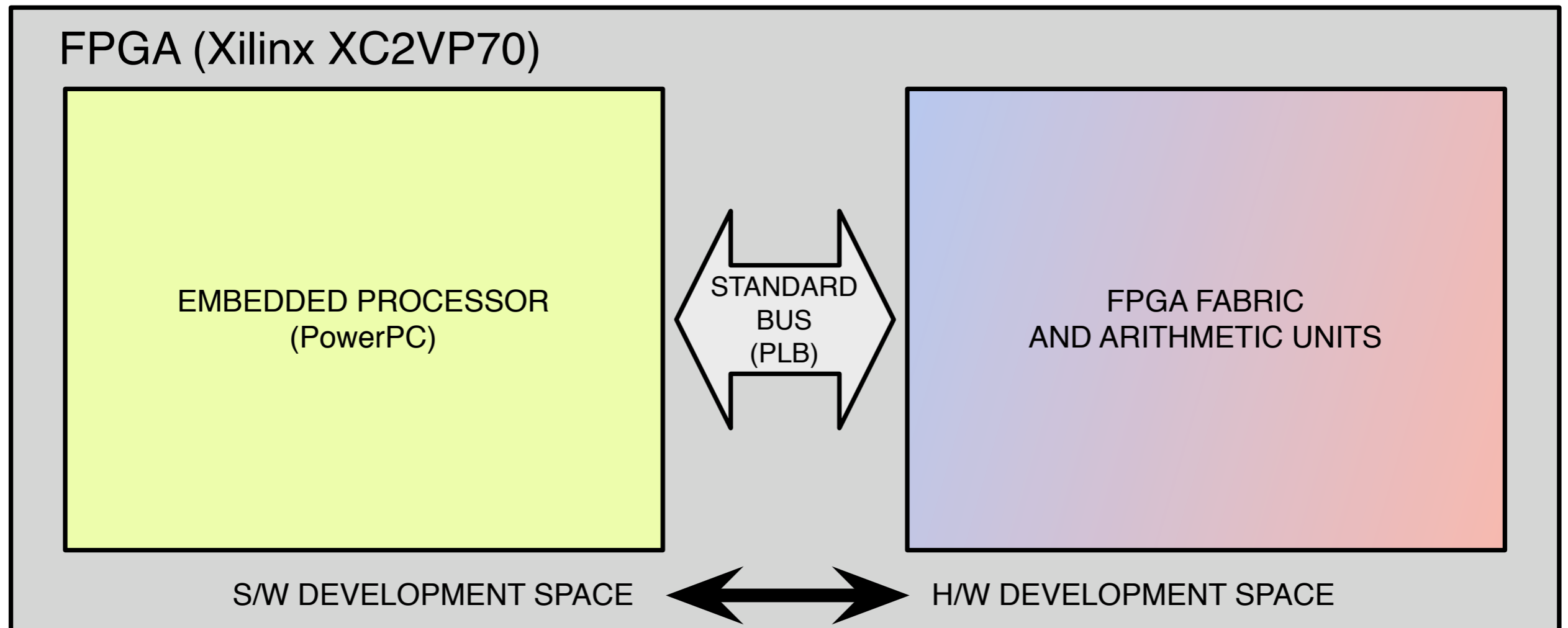

Targeting WARP Hardware

(Understanding the Development Environment)

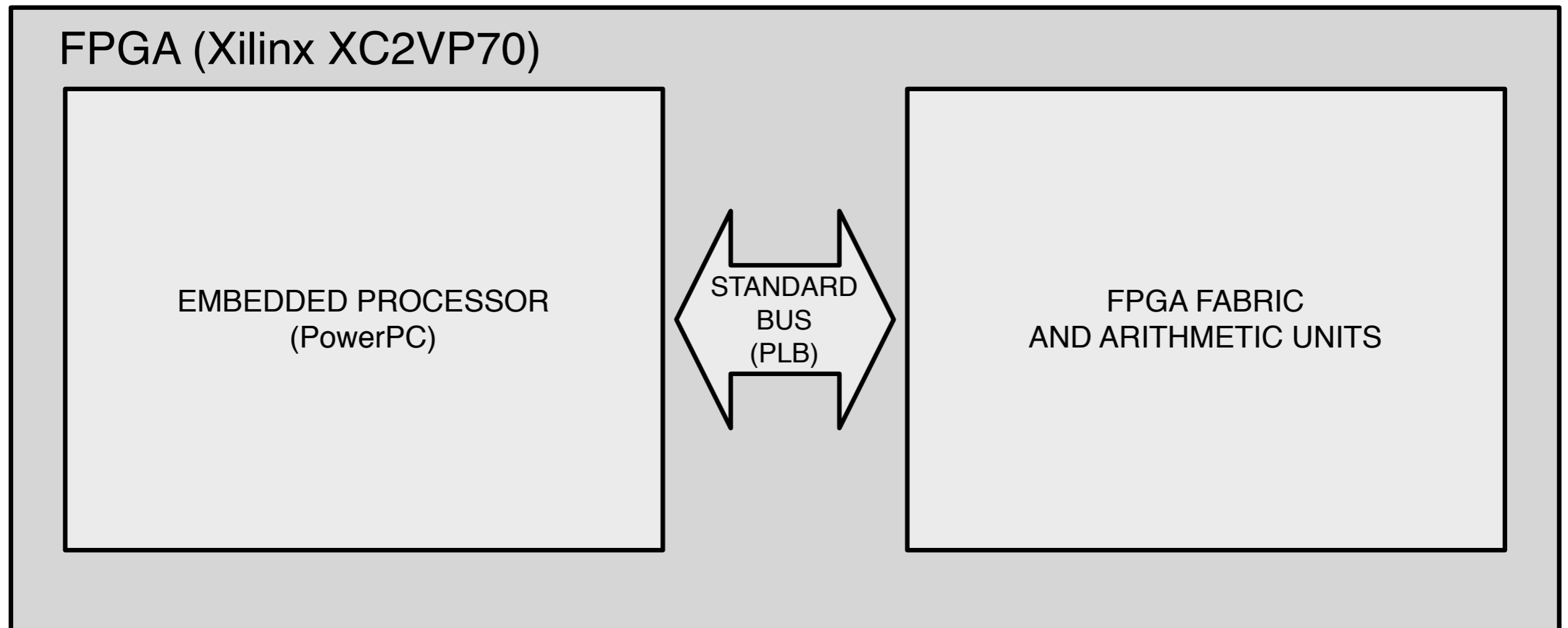

Targeting WARP Hardware

(Understanding the Development Environment)

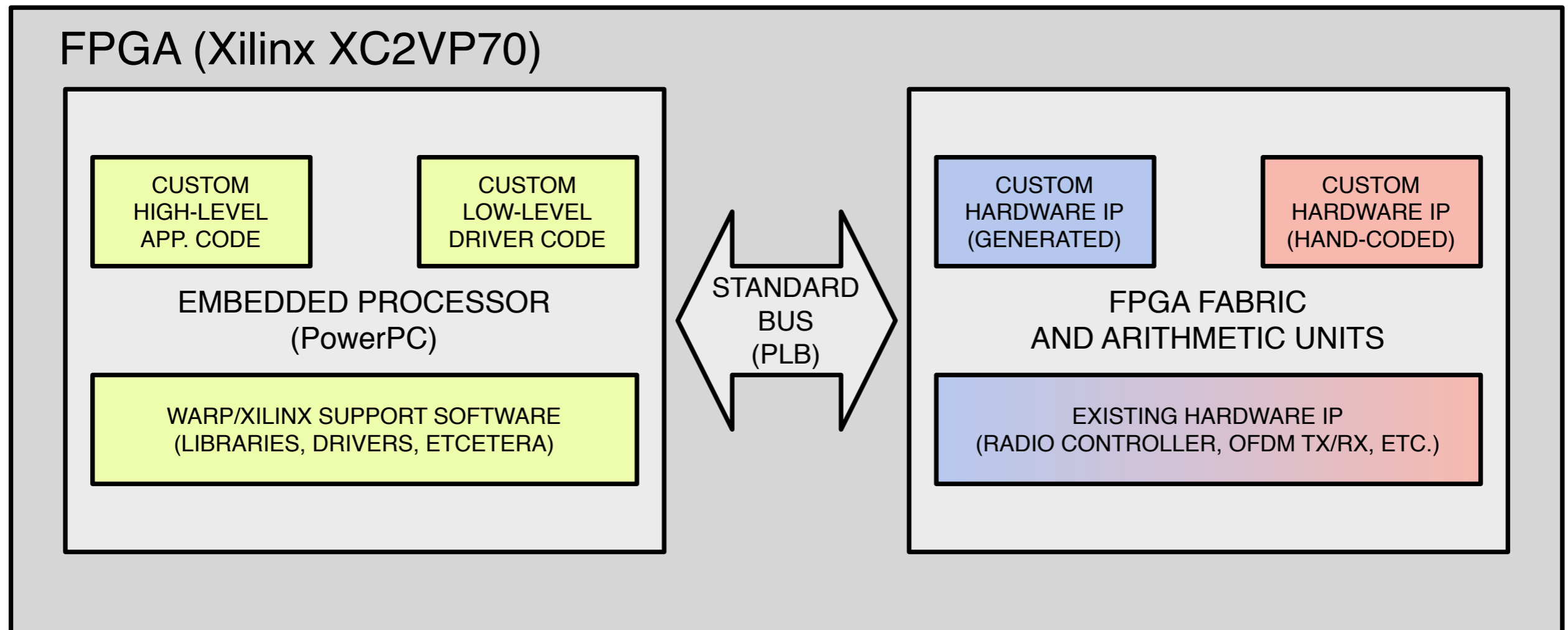

Targeting WARP Hardware

(MAC/Routing Layer Development Space)

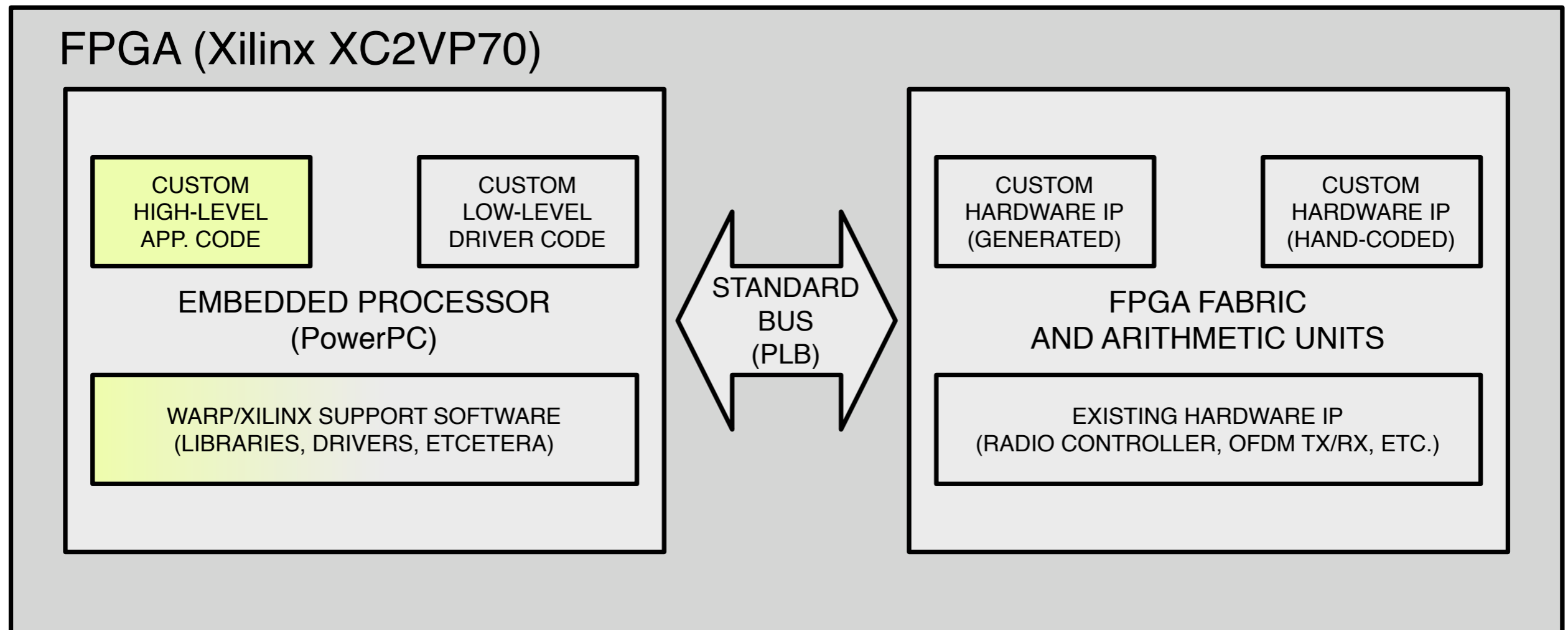

Targeting WARP Hardware

(Physical Layer Development Space)

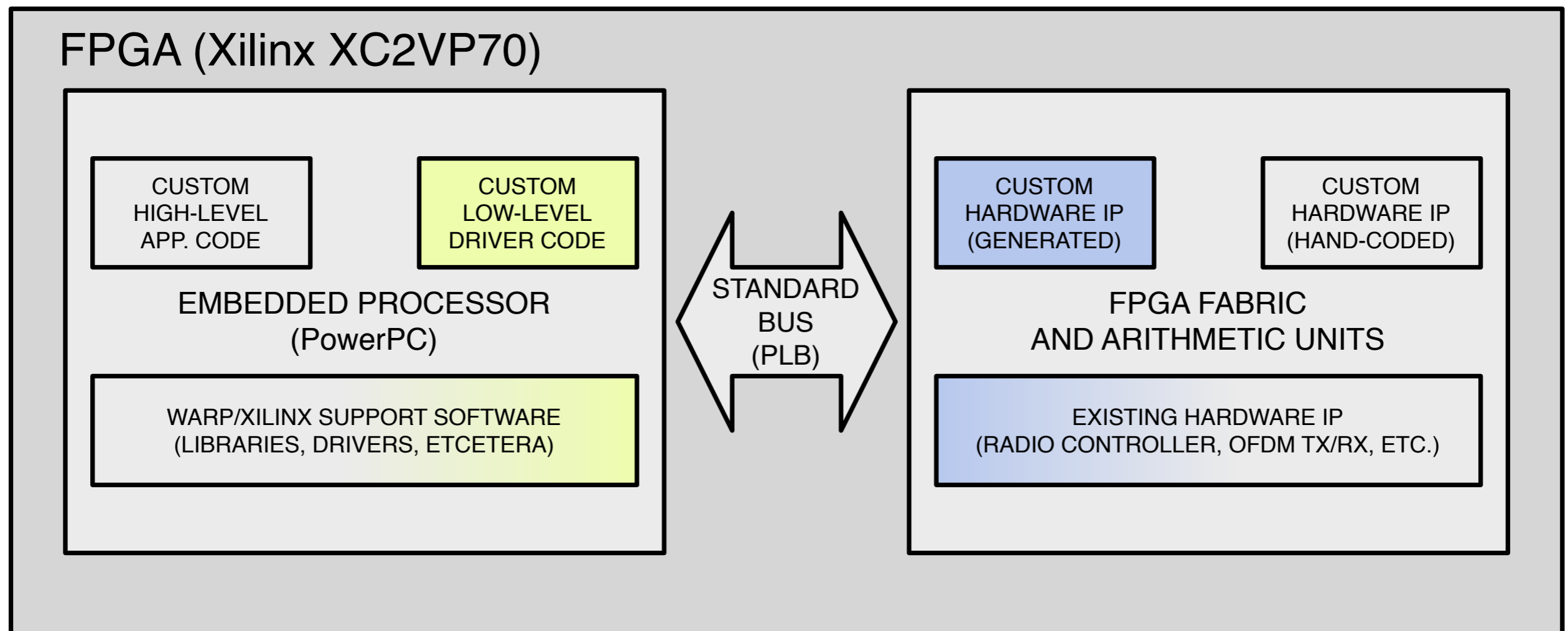

Targeting WARP Hardware

(Architecture Layer Development Space)

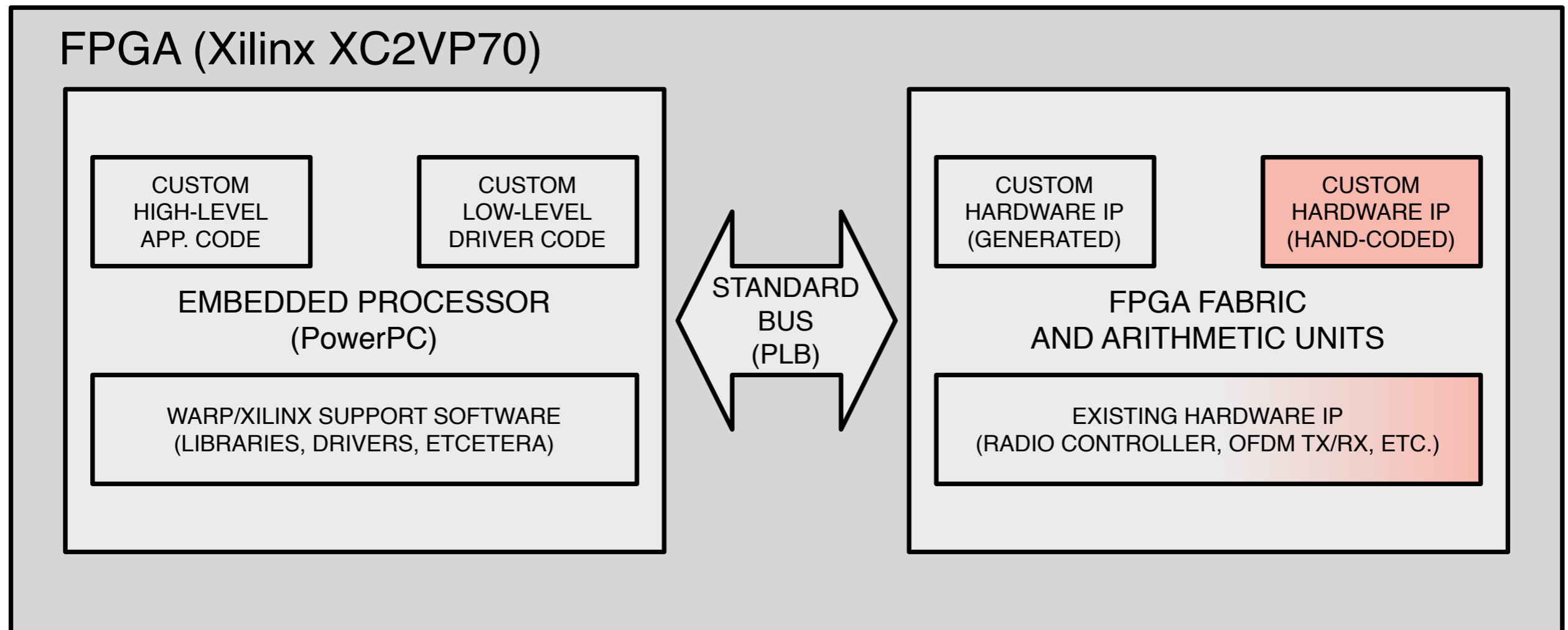

Development Tools

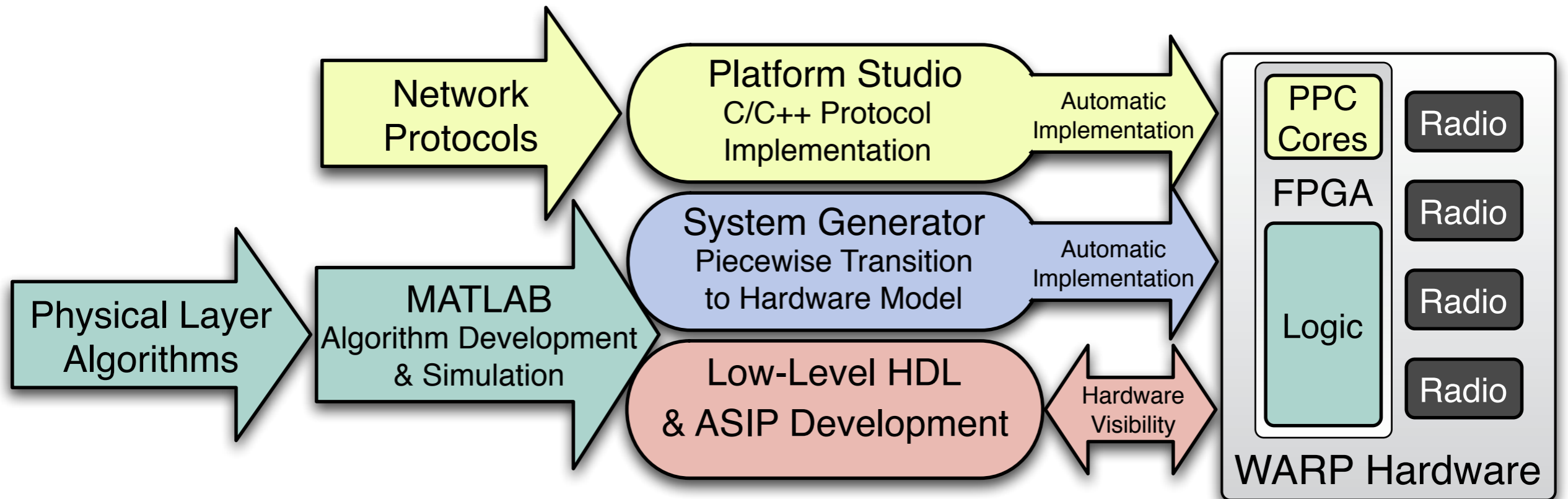

Xilinx Platform Studio

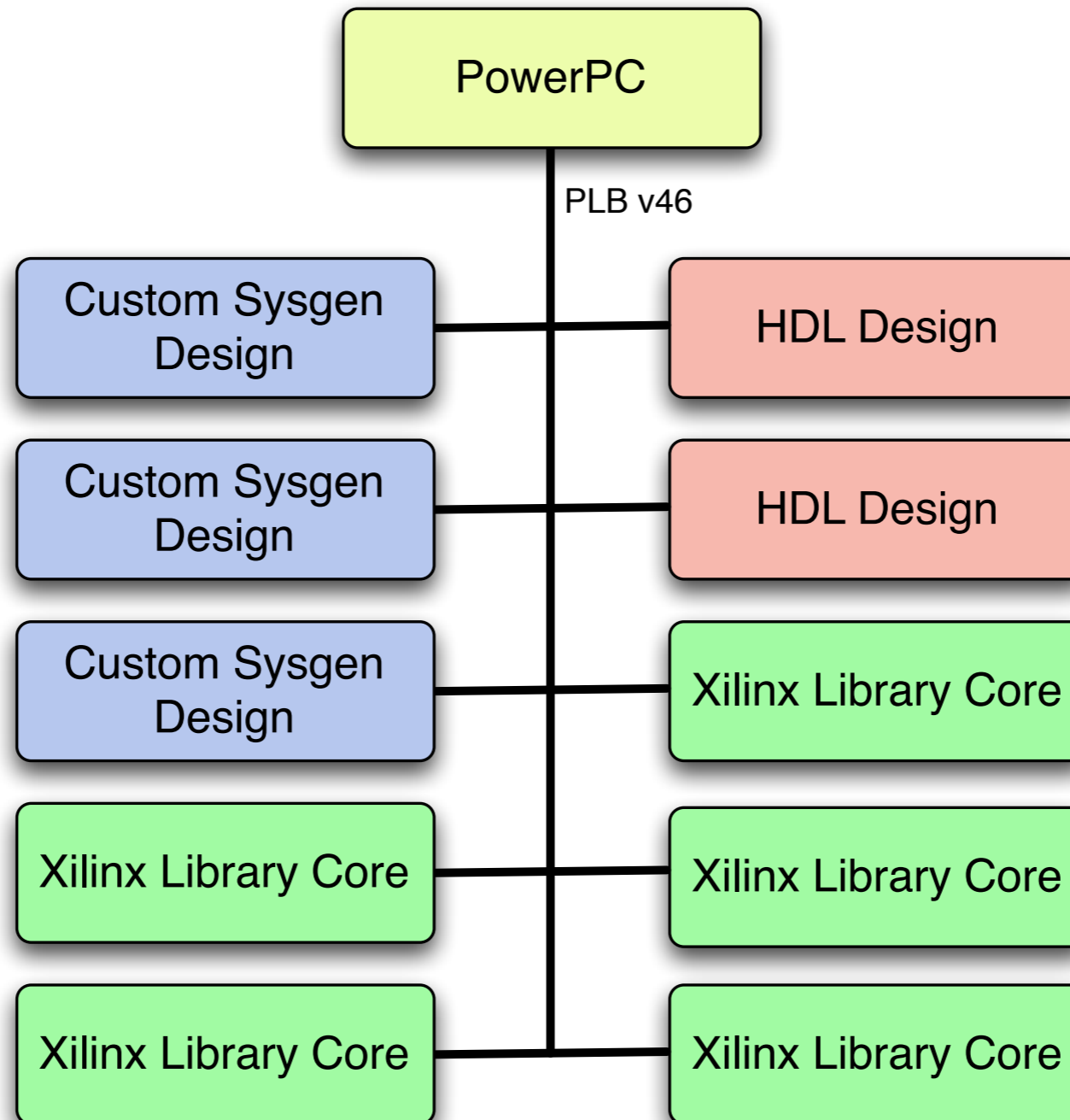

Xilinx Platform Studio

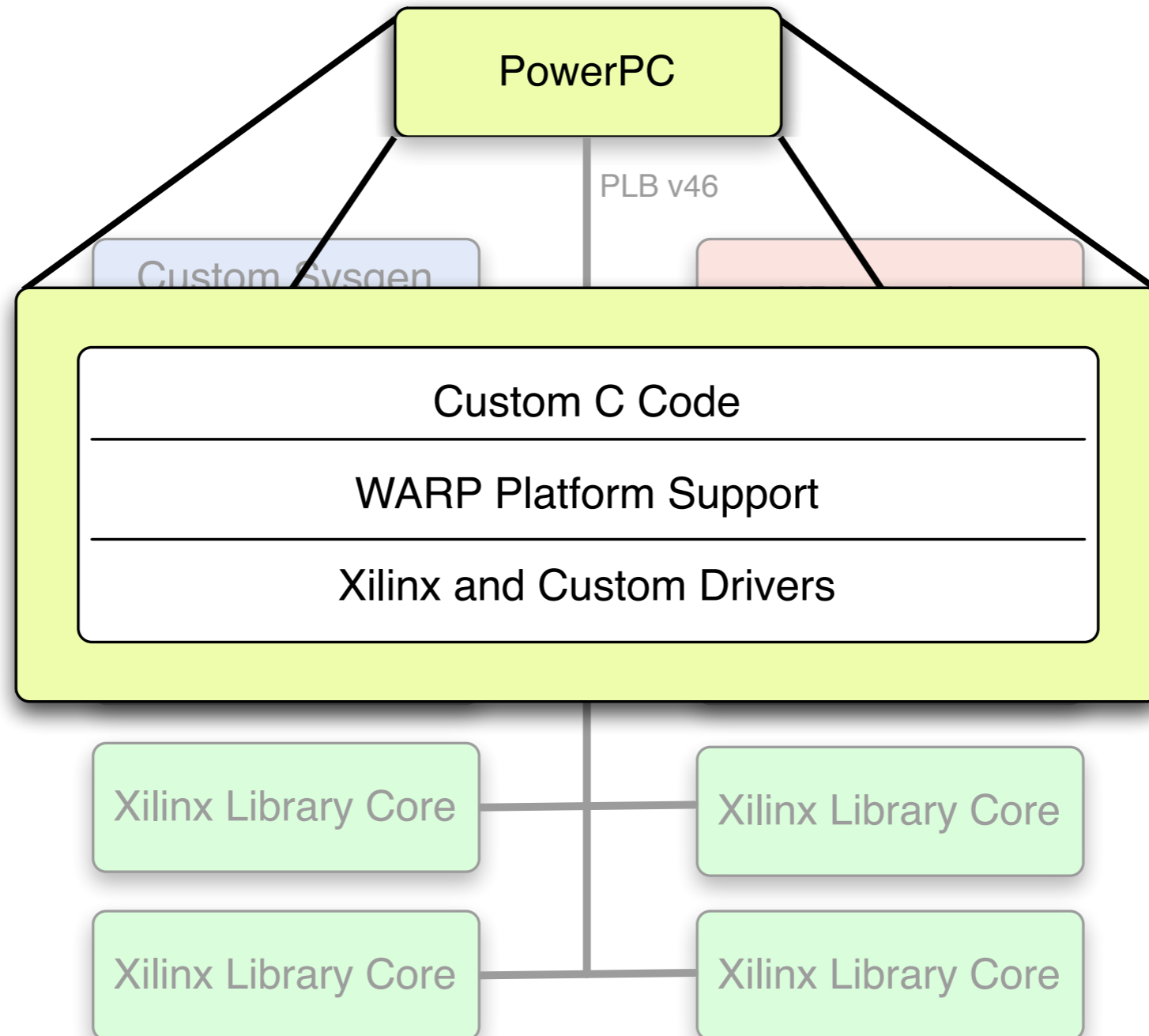

FPGA (Xilinx XC2VP70)

Questions?

CUSTOM
HIGH-LEVEL
APP. CODE

CUSTOM
LOW-LEVEL
DRIVER CODE

CUSTOM
HARDWARE IP
(GENERATED)

CUSTOM
HARDWARE IP
(HAND-CODED)

EMBEDDED PROCESSOR
(PowerPC)

STANDARD
BUS
(PLB)

FPGA FABRIC
AND ARITHMETIC UNITS

WARP/XILINX SUPPORT SOFTWARE
(LIBRARIES, DRIVERS, ETCETERA)

EXISTING HARDWARE IP
(RADIO CONTROLLER, OFDM TX/RX, ETC.)

Lab 2: EDK Introduction

- Introduction to Xilinx Platform Studio
 - Building a simple hardware platform
 - Interacting with the WARP hardware